

21630-804 VARISTAR CP BASE PLATE FOR MOBILE FRAME, MULTI-PIECE, RAL 7021, 600W 900D

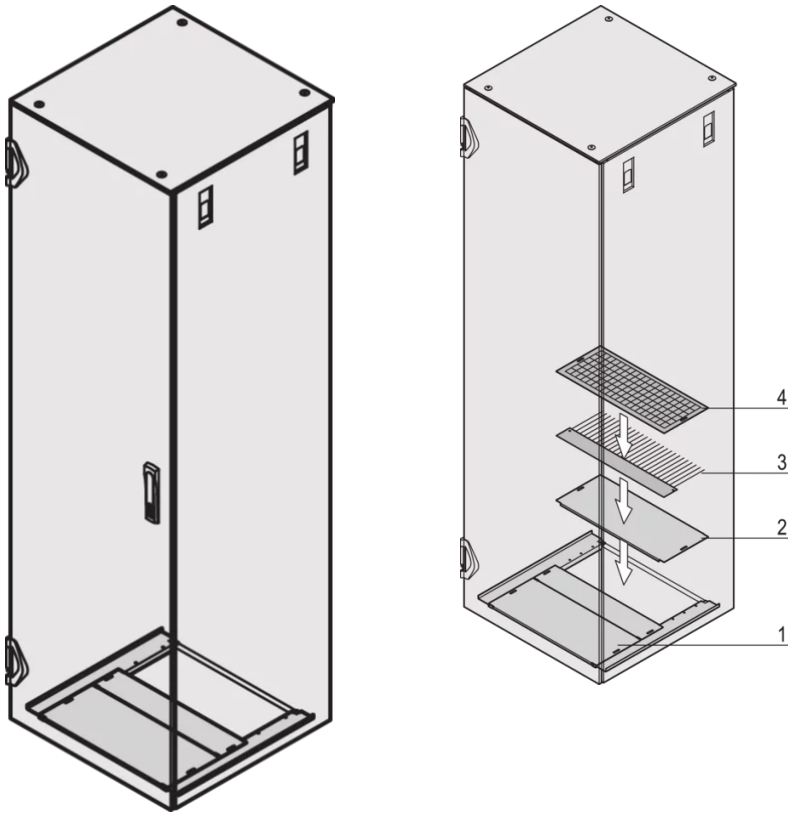

KEY FEATURES

To cover the base opening

The multi-part base plate is open at the rear (opening to rear 200 mm deep, no rear opening with 300 mm cabinet depth)

PRODUCT ATTRIBUTES

Product Type: Cabinet/Rack Base

Product Family: Varistar CP

Material: Steel

Color: Black Grey

Color Code: RAL 7021

Width: 600 mm

Depth: 900 mm

ADDITIONAL PRODUCT DETAILS

Multi piece base plate is assembled from inside.

Please order grounding, cover plate, brush strip or filter mat separately.

Multi piece base plate is assembled from inside.

Please order grounding, cover plate, brush strip or filter mat separately.

North America

All locations
+1.763.422.2661
Chat with us:
schroff.nvent.com

Europe

Straubenhardt, Germany
+49.7082.794.0
Betschdorf, France
+33.3.88.90.64.90
Warsaw, Poland
+48.22.209.98.35
Assago, Italy
+39.02.932.7141
Chat with us:
schroff.nvent.com

Asia

Shanghai, China
+86.21.2412.6943
Qingdao, China
+86.532.8771.6101
Singapore
+65.6768.5800
Shin-Yokohama, Japan
+81.45.476.0271
Chat with us:
schroff.nvent.com

Middle East & India

Dubai, United Arab Emirates
+971.4.378.1700
Bangalore, India
+91.80.6715.2001
Istanbul, Turkey
+90.216.250.7374
Chat with us:
schroff.nvent.com



Our powerful portfolio of brands:
nVent.com **CADDY ERICO HOFFMAN RAYCHEM SCHROFF TRACER**

© 2024 nVent. All nVent marks and logos are owned or licensed by nVent Services GmbH or its affiliates. All other trademarks are the property of their respective owners.

nVent reserves the right to change specifications without notice.