

23130-504 VARISTAR CABLE PANEL FOR COLOCATION CABINET, 496H 110W

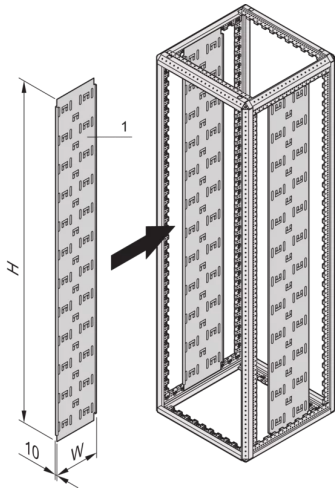

KEY FEATURES

For fitting directly onto the frame

Cables are assembled in place with cable ties or Velcro

PRODUCT ATTRIBUTES

Product Type: Cabinet/Rack Panel

Product Family: Varistar

Type: Cable Panel

Material: Steel

Color: Black Grey

Color Code: RAL 7021

Height: 496 mm

Width: 110 mm

Depth: 10 mm

ADDITIONAL PRODUCT DETAILS

Vertical cable panel for Varistar free standing cabinets powdered in cabinet color in different widths.



North America

All locations
+1.763.422.2661
Chat with us:
schroff.nvent.com

Europe

Straubenhardt, Germany
+49.7082.794.0
Betschdorf, France
+33.3.88.90.64.90
Warsaw, Poland
+48.22.209.98.35
Assago, Italy
+39.02.932.7141
Chat with us:
schroff.nvent.com

Asia

Shanghai, China
+86.21.2412.6943
Qingdao, China
+86.532.8771.6101
Singapore
+65.6768.5800
Shin-Yokohama, Japan
+81.45.476.0271
Chat with us:
schroff.nvent.com

Middle East & India

Dubai, United Arab Emirates
+971.4.378.1700
Bangalore, India
+91.80.6715.2001
Istanbul, Turkey
+90.216.250.7374
Chat with us:
schroff.nvent.com



Our powerful portfolio of brands:
nVent.com **CADDY ERICO HOFFMAN RAYCHEM SCHROFF TRACER**