

14577-143 PROPACPRO PORTABLE CASE, UNSHIELDED, 3 U, 63 HP, 326 MM

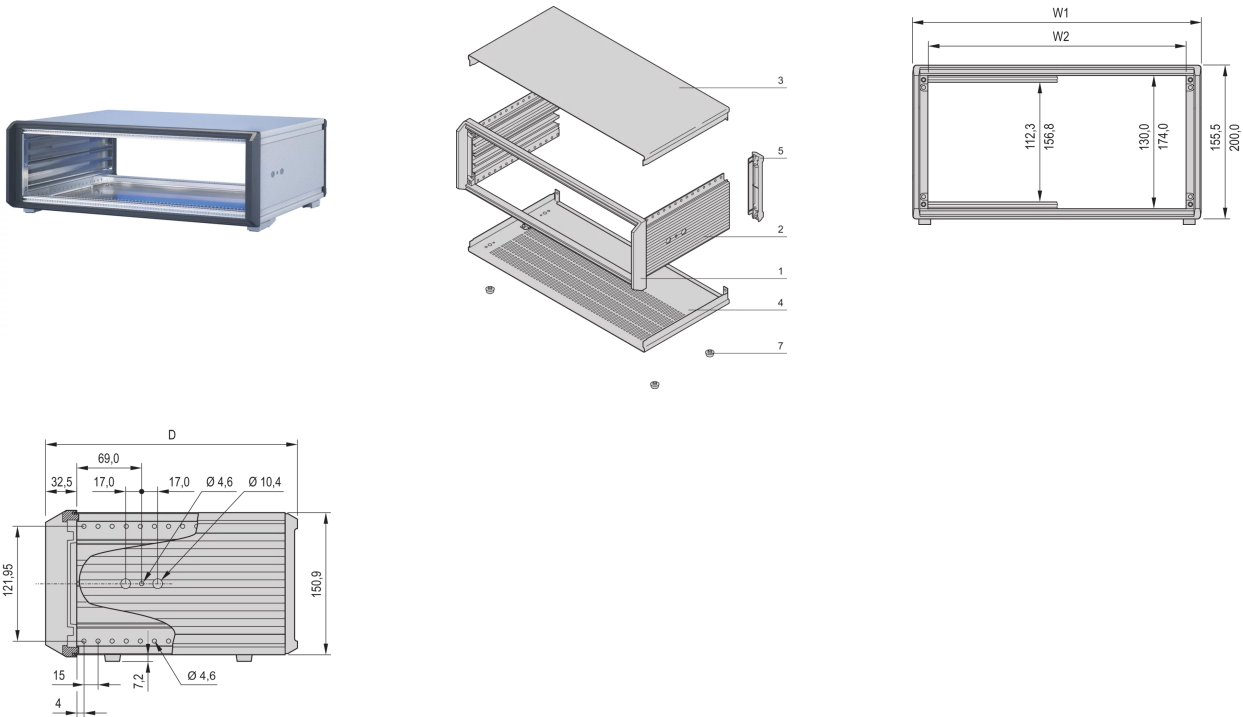

KEY FEATURES

- Desktop case for individual assembly
- Prepared with holes for fitting of tip-up carrying handle
- Retrofitable EMC shielding
- Ventilation slots in base plate
- IP 20 in accordance with IEC 60529
- Prepared for GND/earthing
- Conforms with DIN EN 62368-1

PRODUCT ATTRIBUTES

- Product Type: Case
- Product Family: PropacPRO
- Type: Case for Individual Electronic Components

Rack Height: 3 U

Height: 155.5 mm

Usable Height: 130 mm

Rack Width: 63 HP

Width: 363.7 mm

Usable Width: 326 mm

Depth: 326 mm

EMC Shielding: No (Retrofittable)

Static Load: 25 kg

Protection Rating: IP20

Front Frame Construction: Single Piece

Cooling Option: No

Complies With: IEC 60297-3-101

Package Quantity: 1

ADDITIONAL PRODUCT DETAILS

The nVent SCHROFF PropacPRO case provides electronics protection for 19" and individual electronic assemblies. The aluminum die cast frames and profile sidepanels guarantee a robust solution. In addition this case is prepared for the fitting of a tip-up carrying handle, which is part of the extensive accessory range.

Please order tip up carrying handle separately.

CERTIFICATIONS

The logo features the word "ROHS" in a large, bold, black font with a green checkmark above the letter "O". Below it, the word "COMPLIANT" is written in a smaller, green, sans-serif font.

The logo consists of the letters "DIN" in a large, bold, blue, sans-serif font, enclosed within a blue rectangular border.

North America

All locations

+1.763.422.2661

Chat with us:

schroff.nvent.com

Europe

Straubenhardt, Germany

+49.7082.794.0

Betschdorf, France

+33.3.88.90.64.90

Warsaw, Poland

+48.22.209.98.35

Assago, Italy

+39.02.932.7141

Chat with us:

schroff.nvent.com

Asia

Shanghai, China

+86.21.2412.6943

Qingdao, China

+86.532.8771.6101

Singapore

+65.6768.5800

Shin-Yokohama, Japan

+81.45.476.0271

Chat with us:

schroff.nvent.com

Middle East & India

Dubai, United Arab Emirates

+971.4.378.1700

Bangalore, India

+91.80.6715.2001

Istanbul, Turkey

+90.216.250.7374

Chat with us:

schroff.nvent.com



Our powerful portfolio of brands:
nVent.com **CADDY ERICO HOFFMAN RAYCHEM SCHROFF TRACER**

© 2023 nVent. All nVent marks and logos are owned or licensed by nVent Services GmbH or its affiliates. All other trademarks are the property of their respective owners.

nVent reserves the right to change specifications without notice.