

**34813-971 FRAME TYPE PLUG-IN UNIT COVER PLATE, WITH PERFORATION, 21 HP, 227 MM**

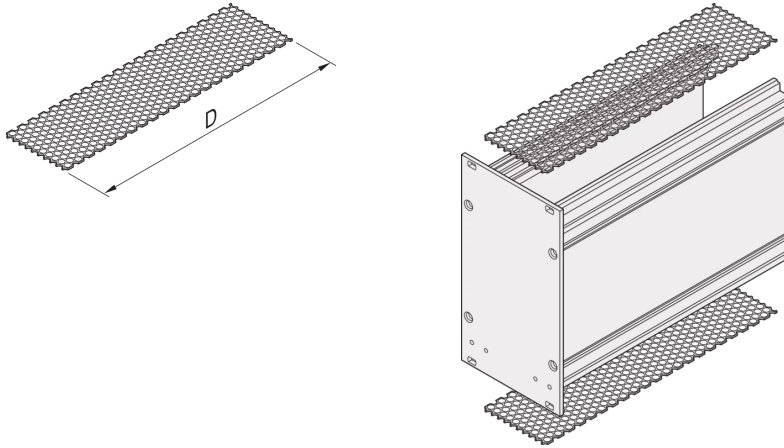

**KEY FEATURES**

Air flow rate-in perforated area approx. 65-%

Cover plate is inserted top and bottom between the side Panels

PCB only possible in slot 1

**PRODUCT ATTRIBUTES**

Product Type: Cover

Type: Cover Plate, Perforated

Works With: Cassettes

Rack Width: 21 HP

Depth: 227 mm

Length: 220 mm

Package Quantity: 10

**ADDITIONAL PRODUCT DETAILS**

Cover plate for frame-type plug-in units, with perforation guarantee an air flow rate by approx. 65%. The plate is inserted into a groove of the side Panel.

Please take into consideration that deliveries may be carried out in the stated SPQs (SPQ, e.g. 5 pieces, 10 pieces, 50 pieces, etc.). Differing order quantities (e.g. 2 pieces) may be changed to the next possible delivery quantity = Standard Pack Quantity.

## CERTIFICATIONS

---



### North America

All locations  
+1.763.422.2661  
Chat with us:  
[schroff.nvent.com](https://schroff.nvent.com)

### Europe

Straubenhardt, Germany  
+49.7082.794.0  
Betschdorf, France  
+33.3.88.90.64.90  
Warsaw, Poland  
+48.22.209.98.35  
Assago, Italy  
+39.02.932.7141  
Chat with us:  
[schroff.nvent.com](https://schroff.nvent.com)

### Asia

Shanghai, China  
+86.21.2412.6943  
Qingdao, China  
+86.532.8771.6101  
Singapore  
+65.6768.5800  
Shin-Yokohama, Japan  
+81.45.476.0271  
Chat with us:  
[schroff.nvent.com](https://schroff.nvent.com)

### Middle East & India

Dubai, United Arab Emirates  
+971.4.378.1700  
Bangalore, India  
+91.80.6715.2001  
Istanbul, Turkey  
+90.216.250.7374  
Chat with us:  
[schroff.nvent.com](https://schroff.nvent.com)



Our powerful portfolio of brands:  
[nVent.com](https://nVent.com) **CADDY ERICO HOFFMAN RAYCHEM SCHROFF TRACER**

© 2023 nVent. All nVent marks and logos are owned or licensed by nVent Services GmbH or its affiliates. All other trademarks are the property of their respective owners.

nVent reserves the right to change specifications without notice.