

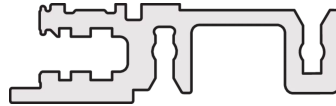

SCHROFF

## 34564-108 FRONT FRAME, UNSHIELDED FOR HORIZONTAL BOARDS MOUNTING, 3 U, 20 HP

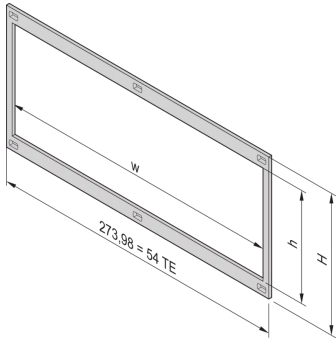

### KEY FEATURES

Front frame, Unshielded, for horizontal-board mounting

### PRODUCT ATTRIBUTES

Product Type: Side Panel

Product Family: EuropacPRO

Rack Height: 3 U

Rack Width: 20 HP

### ADDITIONAL PRODUCT DETAILS

Front frame installation provides the contact between subracks and assemblies. It must be used if a customer has selected a horizontal board mounting Kit.

### CERTIFICATIONS



### North America

All locations

+1.763.422.2661

Chat with us:

[schroff.nvent.com](https://schroff.nvent.com)

### Europe

Straubenhardt, Germany

+49.7082.794.0

Betschdorf, France

+33.3.88.90.64.90

Warsaw, Poland

+48.22.209.98.35

Assago, Italy

+39.02.932.7141

Chat with us:

[schroff.nvent.com](https://schroff.nvent.com)

### Asia

Shanghai, China

+86.21.2412.6943

Qingdao, China

+86.532.8771.6101

Singapore

+65.6768.5800

Shin-Yokohama, Japan

+81.45.476.0271

Chat with us:

[schroff.nvent.com](https://schroff.nvent.com)

### Middle East & India

Dubai, United Arab Emirates

+971.4.378.1700

Bangalore, India

+91.80.6715.2001

Istanbul, Turkey

+90.216.250.7374

Chat with us:

[schroff.nvent.com](https://schroff.nvent.com)



Our powerful portfolio of brands:  
[nVent.com](https://nVent.com) **CADDY ERICO HOFFMAN RAYCHEM SCHROFF TRACER**

© 2023 nVent. All nVent marks and logos are owned or licensed by nVent Services GmbH or its affiliates. All other trademarks are the property of their respective owners.

nVent reserves the right to change specifications without notice.