

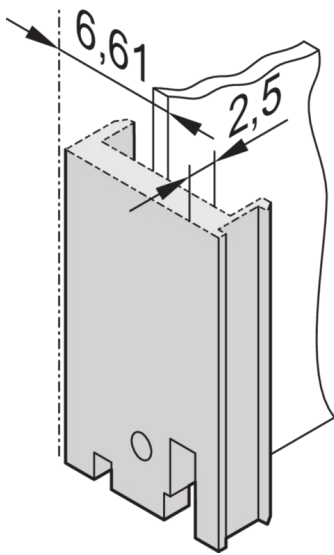

SCHROFF

30848-320 PLUG-IN UNIT U-PROFILE FRONT PANEL FOR IEL, IET, TYPE 2
HANDLE, 6 U, 10 HP, 2.5 MM, AL, FRONT ANODIZED, REAR CONDUCTIVE

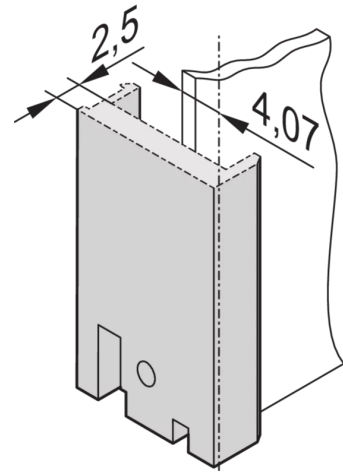

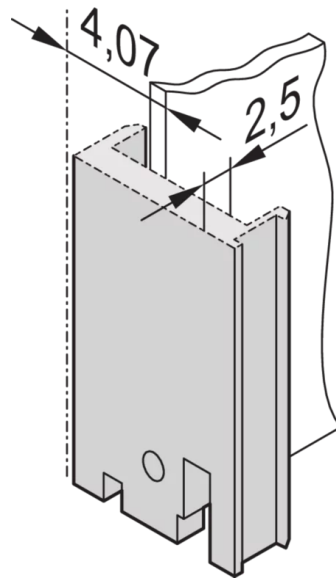
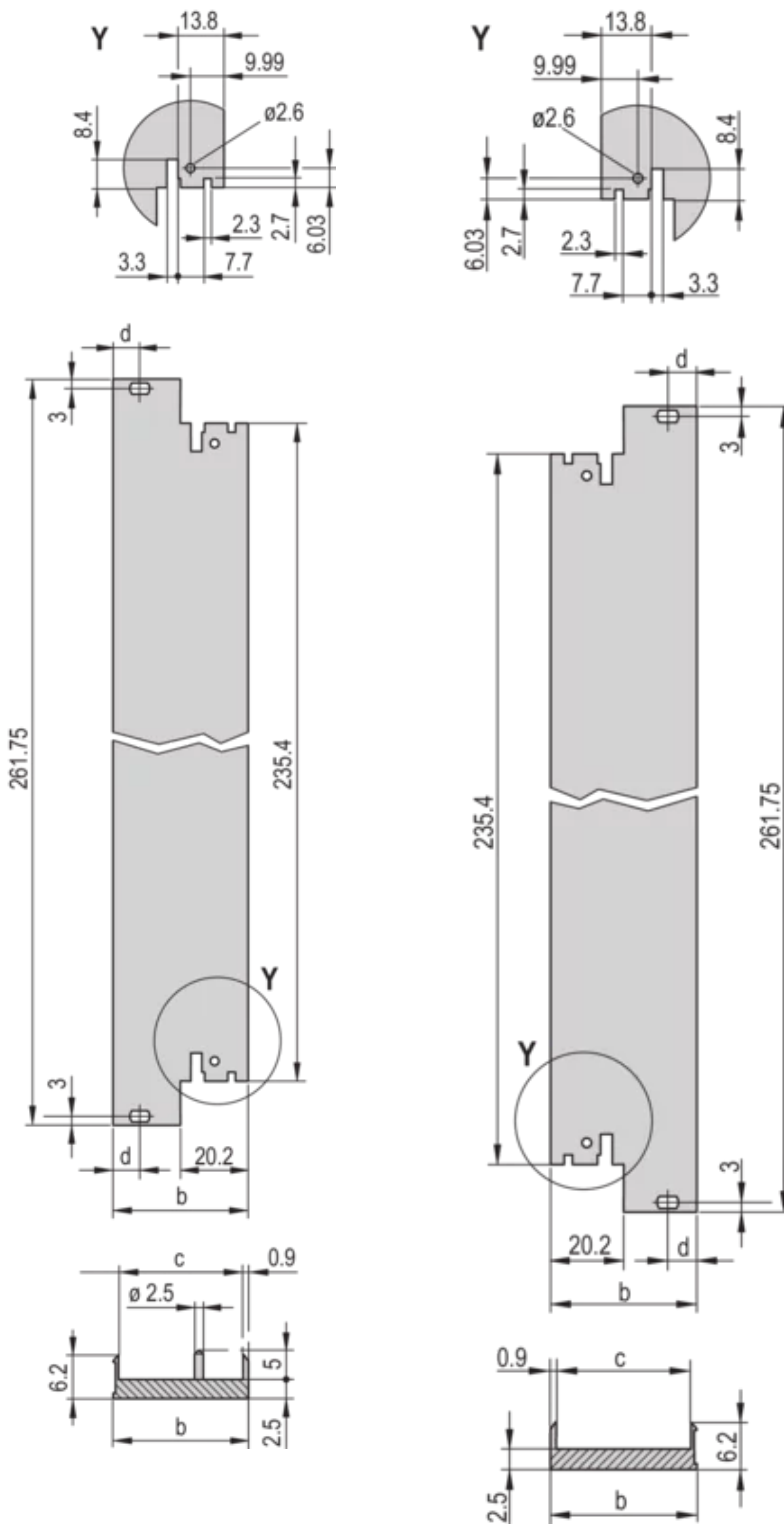

KEY FEATURES

Front panel, 6 U

Al extrusion, 2.5-mm, front-anodized,-rear conductive

U-profile, shieldable with textile EMC gasket

For IEL/IET/Trapeziform Type 2 handle

Manufacturing process causes various surface structures to appear between 4 to 12 HP and 14 to 16 HP

For front mounting, PCB fixing with 0.1" offset

For Rear I/O mounting

PRODUCT ATTRIBUTES

Type: Front Panel for Handle (PIU)

Accessory Type: Front panel

Handle Type: IEL; IET; Trapezoid, Type 2

Mounting: Screw-on Front; Screw-on Rear IO

EMC Shielding: No (Retrofittable)

EMC Gasket Type: Textile

Material: Aluminum

Front Finish: Anodized

Rear Finish: Conductive

Treated Edges: No

Rack Height: 6 U

Rack Width: 10 HP

Height: 261.8 mm

Width: 50.5 mm

Depth: 2.5 mm

Complies With: IEC 60297-3-102; IEEE 1101.10; IEC 60297-3-103; IEEE 1101.1/11

Package Quantity: 5

ADDITIONAL PRODUCT DETAILS

U-Profile front panel can be shielded with a textile gasket. It can be combined with the IEL and IET or the type 2 handle in trapezoid form.

Please order EMC profile seal separately.

Please take into consideration that deliveries may be carried out in the stated SPQs (SPQ, e.g. 5 pieces, 10 pieces, 50 pieces, etc.). Differing order quantities (e.g. 2 pieces) may be changed to the next possible delivery quantity = Standard Pack Quantity.

CERTIFICATIONS



North America

All locations

+1.763.422.2661

Chat with us:

schroff.nvent.com

Europe

Straubenhardt, Germany

+49.7082.794.0

Betschdorf, France

+33.3.88.90.64.90

Warsaw, Poland

+48.22.209.98.35

Assago, Italy

+39.02.932.7141

Chat with us:

schroff.nvent.com

Asia

Shanghai, China

+86.21.2412.6943

Qingdao, China

+86.532.8771.6101

Singapore

+65.6768.5800

Shin-Yokohama, Japan

+81.45.476.0271

Chat with us:

schroff.nvent.com

Middle East & India

Dubai, United Arab Emirates

+971.4.378.1700

Bangalore, India

+91.80.6715.2001

Istanbul, Turkey

+90.216.250.7374

Chat with us:

schroff.nvent.com



Our powerful portfolio of brands:
nVent.com **CADDY ERICO HOFFMAN RAYCHEM SCHROFF TRACER**

© 2023 nVent. All nVent marks and logos are owned or licensed by nVent Services GmbH or its affiliates. All other trademarks are the property of their respective owners.

nVent reserves the right to change specifications without notice.