

28230-070 NOVASTAR CABINET FRAME, SLIM-LINE, 16 U 553W 600D

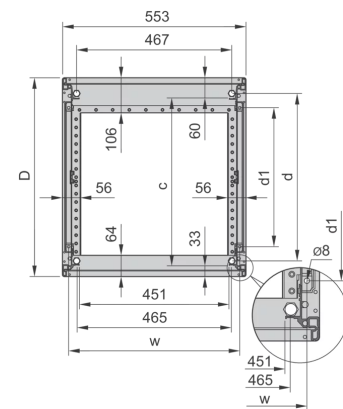
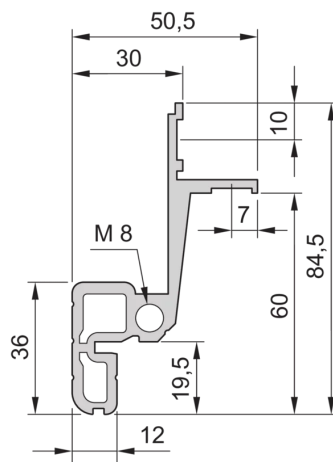
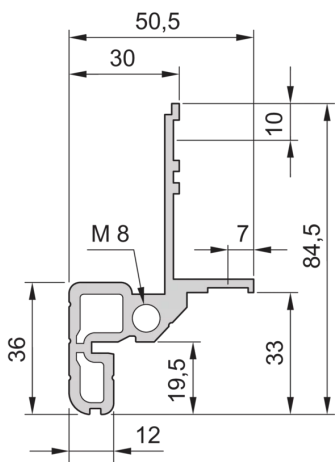
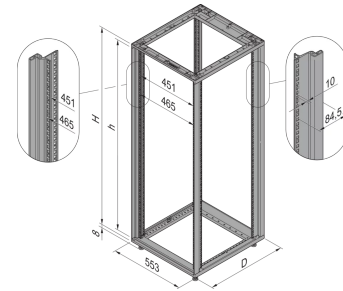
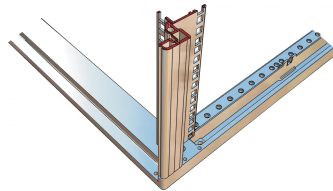
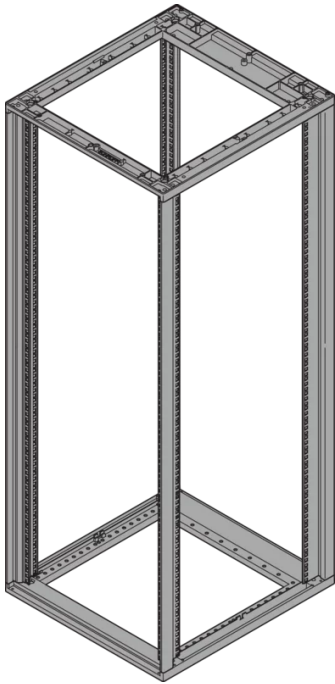

KEY FEATURES

Static load-carrying capacity 200 kg

19" plane - 33 mm at front, 60 mm at rear

Al profile, RAL-7021, incl.-grounding

PRODUCT ATTRIBUTES

Product Type: Cabinet/Rack Frame

Product Family: Novastar

Type: Slim-Line

Frame Material: Aluminum

Color: Black Grey

Color Code: RAL 7021

Rack Height: 16 U

Height: 767 mm

Width: 553 mm

Depth: 600 mm

Static Load: 200 kg

ADDITIONAL PRODUCT DETAILS

Aesthetic aluminum die-cast frame with 200kg static load capacity. Aluminum extruded 19" upright bolted onto the frames.

Please order doors, rear panels, side panels, top cover assemblies, plinths, floors, shelves, slide rails and castors or adjustable feet separately.

CERTIFICATIONS



North America

All locations

+1.763.422.2661

Chat with us:

schroff.nvent.com

Europe

Straubenhardt, Germany

+49.7082.794.0

Betschdorf, France

+33.3.88.90.64.90

Warsaw, Poland

+48.22.209.98.35

Assago, Italy

+39.02.932.7141

Chat with us:

schroff.nvent.com

Asia

Shanghai, China

+86.21.2412.6943

Qingdao, China

+86.532.8771.6101

Singapore

+65.6768.5800

Shin-Yokohama, Japan

+81.45.476.0271

Chat with us:

schroff.nvent.com

Middle East & India

Dubai, United Arab Emirates

+971.4.378.1700

Bangalore, India

+91.80.6715.2001

Istanbul, Turkey

+90.216.250.7374

Chat with us:

schroff.nvent.com



Our powerful portfolio of brands:
nVent.com **CADDY ERICO HOFFMAN RAYCHEM SCHROFF TRACER**

© 2023 nVent. All nVent marks and logos are owned or licensed by nVent Services GmbH or its affiliates. All other trademarks are the property of their respective owners.

nVent reserves the right to change specifications without notice.