

24575-419 COMPACPRO FILLER ANGLE, 6 U

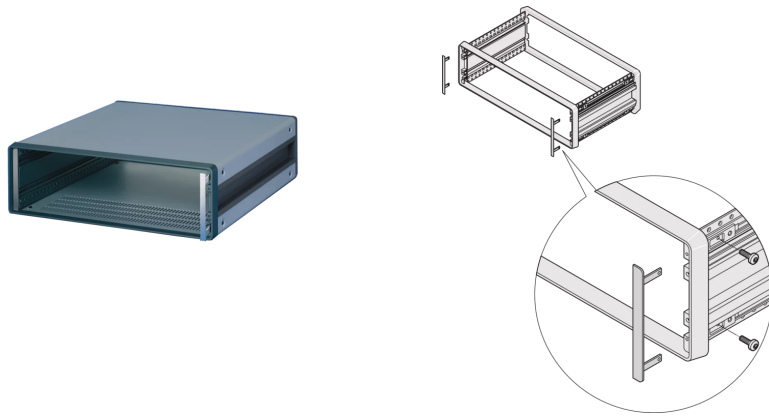

KEY FEATURES

Cover bracket is recommended in event of expansion with horizontal rails

To cover the sides of the rack and to create a continuous front plane with plug-in units and partial front panels

PRODUCT ATTRIBUTES

Product Type: Cover

Type: Filler Angle

Works With: Cases

Rack Height: 6 U

Package Quantity: 2

ADDITIONAL PRODUCT DETAILS

The cover bracket is recommended to cover the die cast frame on the left and right side if horizontal rails will be assembled. Provides a better visual look.

Fixing material is supplied with case.



North America

All locations
+1.763.422.2661
Chat with us:
schroff.nvent.com

Europe

Straubenhardt, Germany
+49.7082.794.0
Betschdorf, France
+33.3.88.90.64.90
Warsaw, Poland
+48.22.209.98.35
Assago, Italy
+39.02.932.7141
Chat with us:
schroff.nvent.com

Asia

Shanghai, China
+86.21.2412.6943
Qingdao, China
+86.532.8771.6101
Singapore
+65.6768.5800
Shin-Yokohama, Japan
+81.45.476.0271
Chat with us:
schroff.nvent.com

Middle East & India

Dubai, United Arab Emirates
+971.4.378.1700
Bangalore, India
+91.80.6715.2001
Istanbul, Turkey
+90.216.250.7374
Chat with us:
schroff.nvent.com



Our powerful portfolio of brands:
nVent.com **CADDY ERICO HOFFMAN RAYCHEM SCHROFF TRACER**