

24572-409 RATIOACPRO AIR RADIAL FAN UNIT, 1 FAN, 42 HP, 220 MM

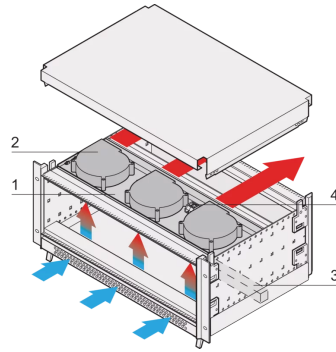
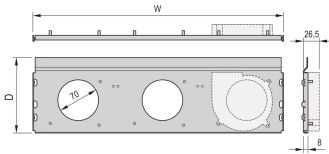

KEY FEATURES

Ball-bearing radial fans

Air capacity 36 m³/h (free blowing) per fan

Fits for RatiopacPRO Air cases (fan unit needs only 0,5 U height)

Only 1/2 U height

Air exhaust via perforation in cover plate

No restriction to rear mounting space

No mechanical modification of the case necessary

Simple mounting

PRODUCT ATTRIBUTES

Product Type: Fan

Product Family: RatiopacPRO AIR

Type: Radial Fan

Works With: Cases

Voltage DC: 12 V

Depth: 220 mm

Rack Width: 42 HP

Airflow: 36 m³/h

Width: 218 mm

ADDITIONAL PRODUCT DETAILS

Simple mountable radial Fan Unit for RatiopacPRO AIR, with a air capacity of 36 m³/h (free blowing) per fan. Available in 4 widths and 2 depths and with up to 3 fans equipped.

CERTIFICATIONS



North America

All locations
+1.763.422.2661
Chat with us:
schroff.nvent.com

Europe

Straubenhardt, Germany
+49.7082.794.0
Betschdorf, France
+33.3.88.90.64.90
Warsaw, Poland
+48.22.209.98.35
Assago, Italy
+39.02.932.7141
Chat with us:
schroff.nvent.com

Asia

Shanghai, China
+86.21.2412.6943
Qingdao, China
+86.532.8771.6101
Singapore
+65.6768.5800
Shin-Yokohama, Japan
+81.45.476.0271
Chat with us:
schroff.nvent.com

Middle East & India

Dubai, United Arab Emirates
+971.4.378.1700
Bangalore, India
+91.80.6715.2001
Istanbul, Turkey
+90.216.250.7374
Chat with us:
schroff.nvent.com



Our powerful portfolio of brands:
nVent.com **CADDY ERICO HOFFMAN RAYCHEM SCHROFF TRACER**

© 2023 nVent. All nVent marks and logos are owned or licensed by nVent Services GmbH or its affiliates. All other trademarks are the property of their respective owners.

nVent reserves the right to change specifications without notice.