

24571-254 RATIOACPRO AIR DESKTOP CASE, RETROFITTABLE SHIELDING, FRONT TRIM, 6/7 U, 42 HP, 255 MM

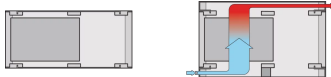
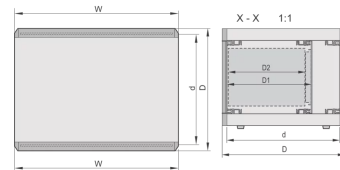
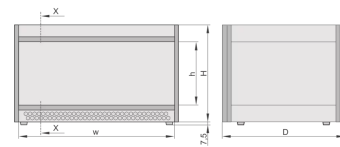
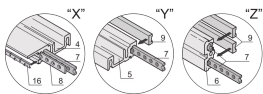
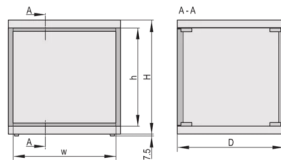
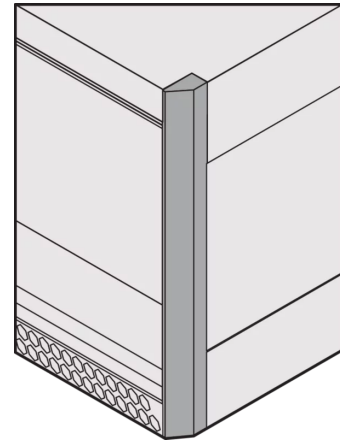
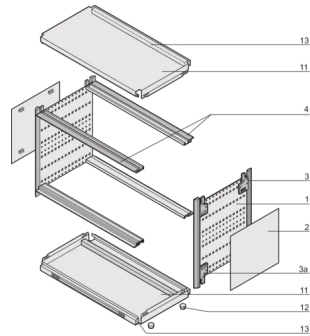

**KEY FEATURES**

Cases for individual assembly with 19" standard components or specific internal mounting, e.g. with mounting plate

Retrofittable EMC shielding

Version with cover strips, no visible screws

The case has 2 x 1/2 U clearances for ventilation beneath and above the board cage

For board depth 160 mm, 220 mm, 280 mm, and 340 mm (depending on case depth)

Symmetrical design, identical front and rear side

Conforms with DIN EN 62368-1

## PRODUCT ATTRIBUTES

---

Product Type: Case

Product Family: RatiopacPRO AIR

Type: Case for Individual Electronic Components

Rack Height: 6 U

Height: 310.35 mm

Usable Height: 245.7 mm

Rack Width: 42 HP

Width: 235.5 mm

Usable Width: 219 mm

Depth: 255.5 mm

EMC Shielding: No (Retrofittable)

Static Load: 25 kg

Protection Rating: IP20

Front Frame Construction: Side Trim; Horizontal Rails

Cooling Option: Yes

Complies With: IEC 60297-3-101; IEC 60297-3-102; IEEE 1101.1; IEEE 1101.10; IEEE 1101.11

Package Quantity: 1

## ADDITIONAL PRODUCT DETAILS

---

The nVent SCHROFF RatiopacPRO case provides electronics protection for 19" and individual electronic assemblies. This flexible and robust case is simple to convert from desktop to a 19" rack mount case and includes four different style options. This version of the case provides advanced cooling capabilities and a sleek design for desktop applications.

Modifications (special colours or sizes).

Custom solutions (cut-outs in top cover, base plate or side panels).

Assembly service from 1 piece.



**North America**

All locations  
+1.763.422.2661  
Chat with us:  
[schroff.nvent.com](https://schroff.nvent.com)

**Europe**

Straubenhardt, Germany  
+49.7082.794.0  
Betschdorf, France  
+33.3.88.90.64.90  
Warsaw, Poland  
+48.22.209.98.35  
Assago, Italy  
+39.02.932.7141  
Chat with us:  
[schroff.nvent.com](https://schroff.nvent.com)

**Asia**

Shanghai, China  
+86.21.2412.6943  
Qingdao, China  
+86.532.8771.6101  
Singapore  
+65.6768.5800  
Shin-Yokohama, Japan  
+81.45.476.0271  
Chat with us:  
[schroff.nvent.com](https://schroff.nvent.com)

**Middle East & India**

Dubai, United Arab Emirates  
+971.4.378.1700  
Bangalore, India  
+91.80.6715.2001  
Istanbul, Turkey  
+90.216.250.7374  
Chat with us:  
[schroff.nvent.com](https://schroff.nvent.com)



Our powerful portfolio of brands:  
[nVent.com](https://nVent.com) **CADDY ERICO HOFFMAN RAYCHEM SCHROFF TRACER**