

24571-187 RATIOACPRO AIR DESKTOP CASE, RETROFITTABLE SHIELDING, FRONT TRIM, 3/4 U, 84 HP, 435 MM

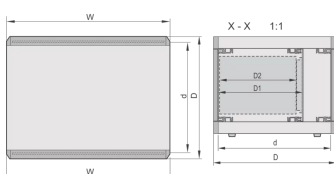
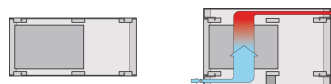
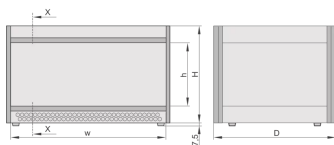
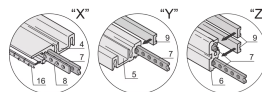
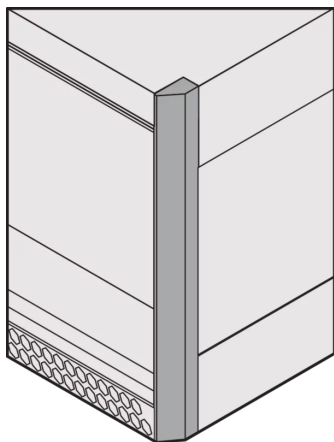
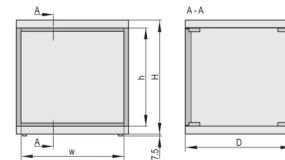
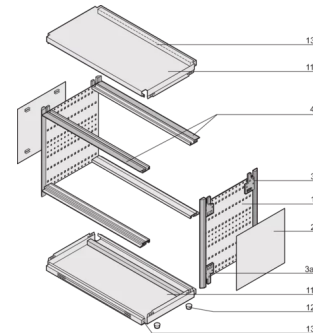

KEY FEATURES

Cases for individual assembly with 19" standard components or specific internal mounting, e.g. with mounting plate

Retrofittable EMC shielding

Version with cover strips, no visible screws

The case has 2 x 1/2 U clearances for ventilation beneath and above the board cage

For board depth 160 mm, 220 mm, 280 mm, and 340 mm (depending on case depth)

Symmetrical design, identical front and rear side

Conforms with DIN EN 62368-1

PRODUCT ATTRIBUTES

Product Type: Case

Product Family: RatiopacPRO AIR

Type: Case for Individual Electronic Components

Rack Height: 3 U

Height: 177 mm

Usable Height: 112.3 mm

Rack Width: 84 HP

Width: 448.9 mm

Usable Width: 432 mm

Depth: 435.5 mm

EMC Shielding: No (Retrofittable)

Static Load: 25 kg

Protection Rating: IP20

Front Frame Construction: Side Trim; Horizontal Rails

Cooling Option: Yes

Complies With: IEC 60297-3-101; IEC 60297-3-102; IEEE 1101.1; IEEE 1101.10; IEEE 1101.11

Package Quantity: 1

ADDITIONAL PRODUCT DETAILS

The nVent SCHROFF RatiopacPRO case provides electronics protection for 19" and individual electronic assemblies. This flexible and robust case is simple to convert from desktop to a 19" rack mount case and includes four different style options. This version of the case provides advanced cooling capabilities and a sleek design for desktop applications.

Modifications (special colours or sizes).

Custom solutions (cut-outs in top cover, base plate or side panels).

Assembly service from 1 piece.



North America

All locations
+1.763.422.2661
Chat with us:
schroff.nvent.com

Europe

Straubenhardt, Germany
+49.7082.794.0
Betschdorf, France
+33.3.88.90.64.90
Warsaw, Poland
+48.22.209.98.35
Assago, Italy
+39.02.932.7141
Chat with us:
schroff.nvent.com

Asia

Shanghai, China
+86.21.2412.6943
Qingdao, China
+86.532.8771.6101
Singapore
+65.6768.5800
Shin-Yokohama, Japan
+81.45.476.0271
Chat with us:
schroff.nvent.com

Middle East & India

Dubai, United Arab Emirates
+971.4.378.1700
Bangalore, India
+91.80.6715.2001
Istanbul, Turkey
+90.216.250.7374
Chat with us:
schroff.nvent.com



Our powerful portfolio of brands:
nVent.com **CADDY ERICO HOFFMAN RAYCHEM SCHROFF TRACER**