

24562-542 EMC SHIELDING KIT, BETWEEN HORIZONTAL RAILS, STAINLESS STEEL, 42 HP

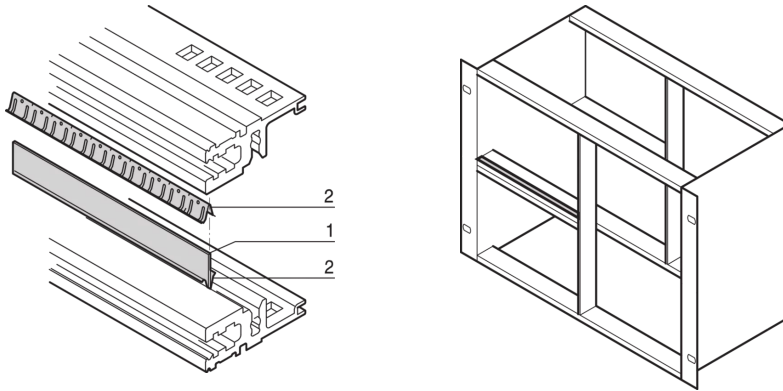

KEY FEATURES

If two horizontal rails are mounted one above the other, the seals plus a metal strip enable EMC shielding

PRODUCT ATTRIBUTES

Product Type: Shielding Kit

Product Family: EuropacPRO

Rack Width: 42 HP

Package Quantity: 1

Length: 218 mm

ADDITIONAL PRODUCT DETAILS

The contact strip makes contact between horizontal rails. If two horizontal rails are mounted one above the other, the seals plus a metal strip enable EMC shielding.

CERTIFICATIONS



North America

All locations

+1.763.422.2661

Chat with us:

schroff.nvent.com

Europe

Straubenhardt, Germany

+49.7082.794.0

Betschdorf, France

+33.3.88.90.64.90

Warsaw, Poland

+48.22.209.98.35

Assago, Italy

+39.02.932.7141

Chat with us:

schroff.nvent.com

Asia

Shanghai, China

+86.21.2412.6943

Qingdao, China

+86.532.8771.6101

Singapore

+65.6768.5800

Shin-Yokohama, Japan

+81.45.476.0271

Chat with us:

schroff.nvent.com

Middle East & India

Dubai, United Arab Emirates

+971.4.378.1700

Bangalore, India

+91.80.6715.2001

Istanbul, Turkey

+90.216.250.7374

Chat with us:

schroff.nvent.com



Our powerful portfolio of brands:
nVent.com **CADDY ERICO HOFFMAN RAYCHEM SCHROFF TRACER**

© 2023 nVent. All nVent marks and logos are owned or licensed by nVent Services GmbH or its affiliates. All other trademarks are the property of their respective owners.

nVent reserves the right to change specifications without notice.