

23130-009 VARISTAR BASE PLATE, MULTI-PIECE, 600W 300D

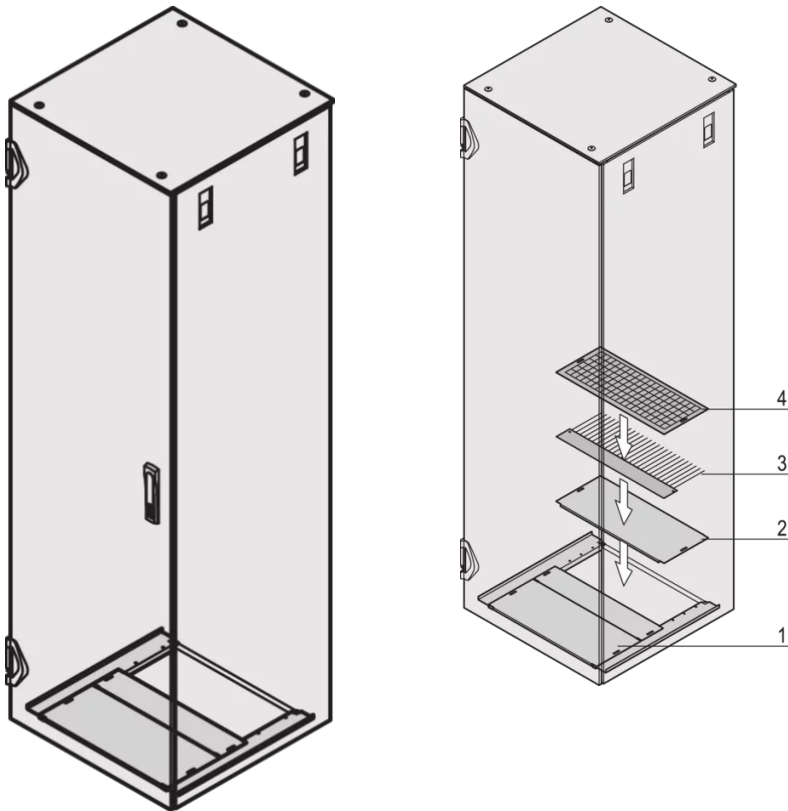

KEY FEATURES

St, 1.5 mm

To cover the base opening

Incl. GND/grounding

The multi-part base plate is open at the rear (opening to rear 200 mm deep no rear opening with 300 mm cabinet depth)

PRODUCT ATTRIBUTES

Product Type: Cabinet/Rack Base

Product Family: Varistar

Type: Base Plate, Solid

Material: Steel

Color: Black Grey

Color Code: RAL 7021

Width: 600 mm

Depth: 300 mm

ADDITIONAL PRODUCT DETAILS

Multi piece base plate including grounding.

Is assembled from inside.

Please order cover plate, brush strip or filter mat separately.

CERTIFICATIONS



North America

All locations

+1.763.422.2661

Chat with us:

schroff.nvent.com

Europe

Straubenhardt, Germany

+49.7082.794.0

Betschdorf, France

+33.3.88.90.64.90

Warsaw, Poland

+48.22.209.98.35

Assago, Italy

+39.02.932.7141

Chat with us:

schroff.nvent.com

Asia

Shanghai, China

+86.21.2412.6943

Qingdao, China

+86.532.8771.6101

Singapore

+65.6768.5800

Shin-Yokohama, Japan

+81.45.476.0271

Chat with us:

schroff.nvent.com

Middle East & India

Dubai, United Arab Emirates

+971.4.378.1700

Bangalore, India

+91.80.6715.2001

Istanbul, Turkey

+90.216.250.7374

Chat with us:

schroff.nvent.com



Our powerful portfolio of brands:
nVent.com **CADDY ERICO HOFFMAN RAYCHEM SCHROFF TRACER**

© 2023 nVent. All nVent marks and logos are owned or licensed by nVent Services GmbH or its affiliates. All other trademarks are the property of their respective owners.

nVent reserves the right to change specifications without notice.