

20838-084 ETSIRACK 19" TO 21" ADAPTER KIT, 3 U

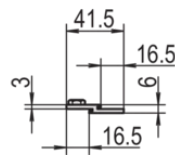
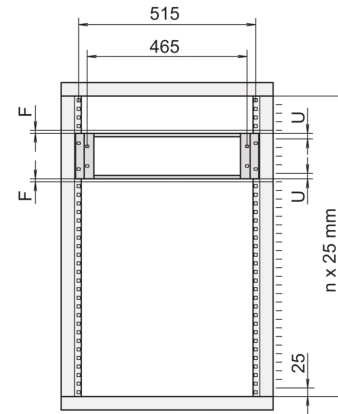
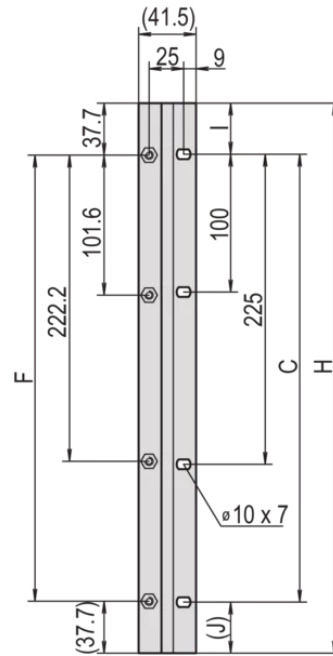
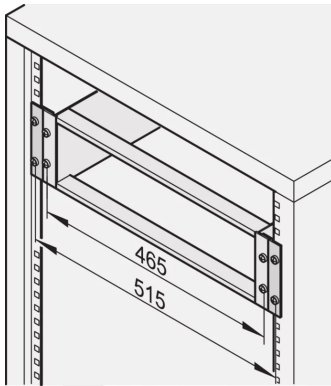

KEY FEATURES

Equal clearances are obtained above and below between the 19" adaptor and the metric height increments

The 19" adaptor allows 19" components to be installed in the metric Etsirack

PRODUCT ATTRIBUTES

Product Type: Adapter

Type: Etsirack

Works With: Subracks

Rack Height: 3 U

ADDITIONAL PRODUCT DETAILS

The 19" adaptor allows 19" components to be installed in the metric Etsirack.

Assembly dimensions and clearances see drawing.

CERTIFICATIONS



North America

All locations
+1.763.422.2661
Chat with us:
schroff.nvent.com

Europe

Straubenhardt, Germany
+49.7082.794.0
Betschdorf, France
+33.3.88.90.64.90
Warsaw, Poland
+48.22.209.98.35
Assago, Italy
+39.02.932.7141
Chat with us:
schroff.nvent.com

Asia

Shanghai, China
+86.21.2412.6943
Qingdao, China
+86.532.8771.6101
Singapore
+65.6768.5800
Shin-Yokohama, Japan
+81.45.476.0271
Chat with us:
schroff.nvent.com

Middle East & India

Dubai, United Arab Emirates
+971.4.378.1700
Bangalore, India
+91.80.6715.2001
Istanbul, Turkey
+90.216.250.7374
Chat with us:
schroff.nvent.com



Our powerful portfolio of brands:
nVent.com **CADDY ERICO HOFFMAN RAYCHEM SCHROFF TRACER**

© 2023 nVent. All nVent marks and logos are owned or licensed by nVent Services GmbH or its affiliates. All other trademarks are the property of their respective owners.

nVent reserves the right to change specifications without notice.