

20822-047 EUROPACPRO PERFORATED RAIL FOR CONNECTOR, ACCORDING TO EN 60603-2 AND DIN 41612, 60 HP

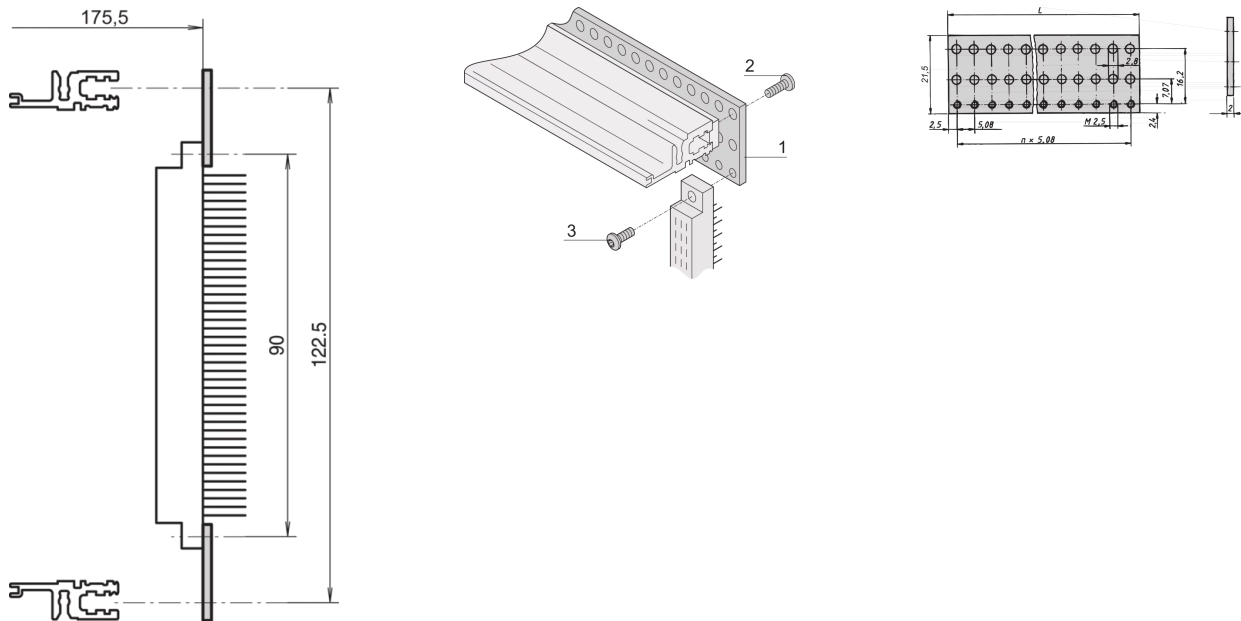

KEY FEATURES

In conjunction with rear horizontal rails, VT

For Connector Mounting in accordance with EN 60603-2, DIN 41612

PRODUCT ATTRIBUTES

Product Type: Perforated Rail

Product Family: EuropacPRO; RatiopacPRO; RatiopacPRO AIR; CompacPRO; PropacPRO

Works With: Subracks; Cases

Rack Width: 60 HP

Length: 304.8 mm

Package Quantity: 4

ADDITIONAL PRODUCT DETAILS

Perforated flat rail for connector mounting i.a.w. EN 60603-2 and DIN 41612, on VT horizontal rails.

A threaded insert is required to secure the perforated rail on the horizontal rail.

CERTIFICATIONS



North America

All locations
+1.763.422.2661
Chat with us:
schroff.nvent.com

Europe

Straubenhardt, Germany
+49.7082.794.0
Betschdorf, France
+33.3.88.90.64.90
Warsaw, Poland
+48.22.209.98.35
Assago, Italy
+39.02.932.7141
Chat with us:
schroff.nvent.com

Asia

Shanghai, China
+86.21.2412.6943
Qingdao, China
+86.532.8771.6101
Singapore
+65.6768.5800
Shin-Yokohama, Japan
+81.45.476.0271
Chat with us:
schroff.nvent.com

Middle East & India

Dubai, United Arab Emirates
+971.4.378.1700
Bangalore, India
+91.80.6715.2001
Istanbul, Turkey
+90.216.250.7374
Chat with us:
schroff.nvent.com



Our powerful portfolio of brands:
nVent.com **CADDY ERICO HOFFMAN RAYCHEM SCHROFF TRACER**

© 2023 nVent. All nVent marks and logos are owned or licensed by nVent Services GmbH or its affiliates. All other trademarks are the property of their respective owners.

nVent reserves the right to change specifications without notice.