

20817-445 PLUG-IN UNIT KIT WITH EXTRACTION HANDLE TYPE 1, UNSHIELDED, GREY, 3 U, 6 HP

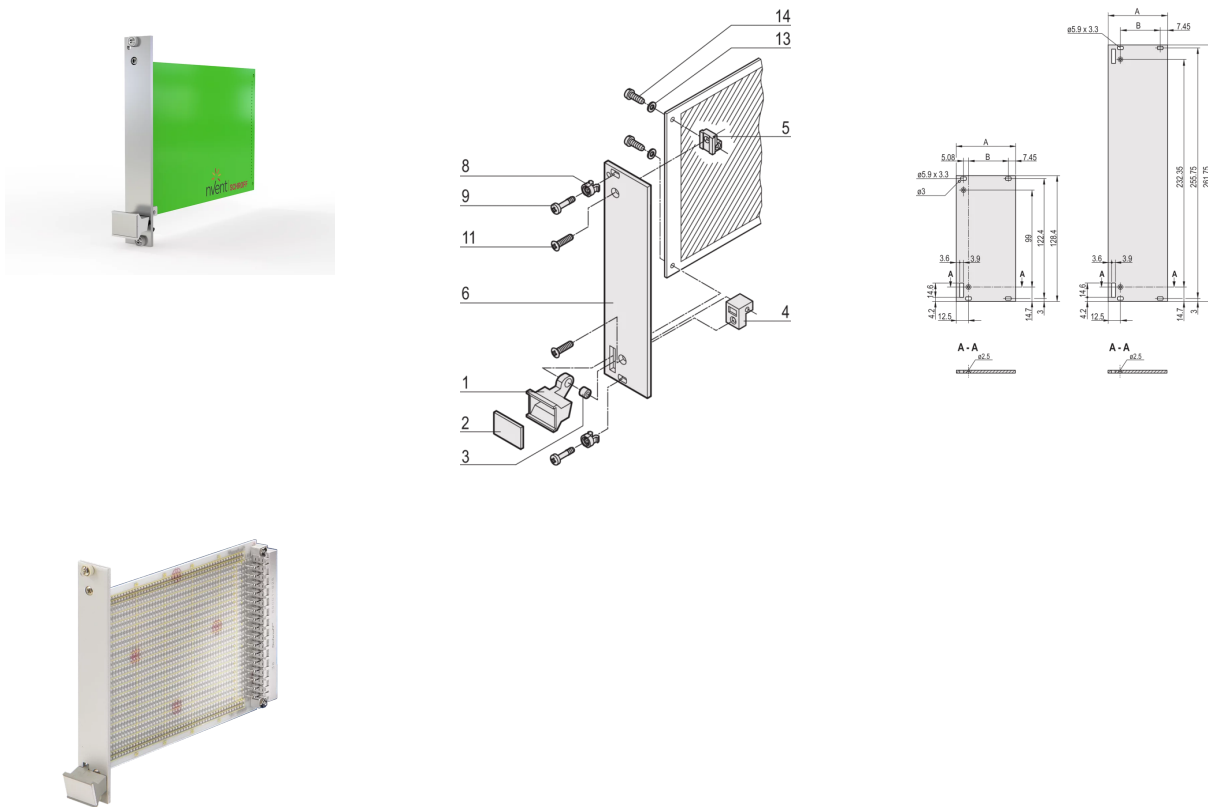

KEY FEATURES

Front panel, flat, unshielded

Handle with extraction function

PRODUCT ATTRIBUTES

Product Type: Front Panel

Type: Front Panel with Handle (PIU)

Handle Type: Trapezoid, Type 1

Mounting: Screw-on Front

EMC Shielding: No

Material: Aluminum

Front Finish: Anodized

Rear Finish: Passivated

Treated Edges: No

Rack Height: 3 U

Height: 128.4 mm

Rack Width: 6 HP

Width: 30.1 mm

Complies With: EN 45545-2, R22-R24, HL3; IEC 60297-3-101; IEEE 1101.1/11

Flammability Rating: UL® 94V-0

Package Quantity: 1

ADDITIONAL PRODUCT DETAILS

Plug-in unit, with extraction handle type 1 and flat panel. The grey handle is assembled on the front panel.

CERTIFICATIONS



North America

All locations

+1.763.422.2661

Chat with us:

schroff.nvent.com

Europe

Straubenhardt, Germany

+49.7082.794.0

Betschdorf, France

+33.3.88.90.64.90

Warsaw, Poland

+48.22.209.98.35

Assago, Italy

+39.02.932.7141

Chat with us:

schroff.nvent.com

Asia

Shanghai, China

+86.21.2412.6943

Qingdao, China

+86.532.8771.6101

Singapore

+65.6768.5800

Shin-Yokohama, Japan

+81.45.476.0271

Chat with us:

schroff.nvent.com

Middle East & India

Dubai, United Arab Emirates

+971.4.378.1700

Bangalore, India

+91.80.6715.2001

Istanbul, Turkey

+90.216.250.7374

Chat with us:

schroff.nvent.com



Our powerful portfolio of brands:
nVent.com **CADDY ERICO HOFFMAN RAYCHEM SCHROFF TRACER**

© 2023 nVent. All nVent marks and logos are owned or licensed by nVent Services GmbH or its affiliates. All other trademarks are the property of their respective owners.

nVent reserves the right to change specifications without notice.