

## 20808-088 STATIC HANDLE PLASTIC IN TRAPEZOID FORM, BLACK, 21 HP

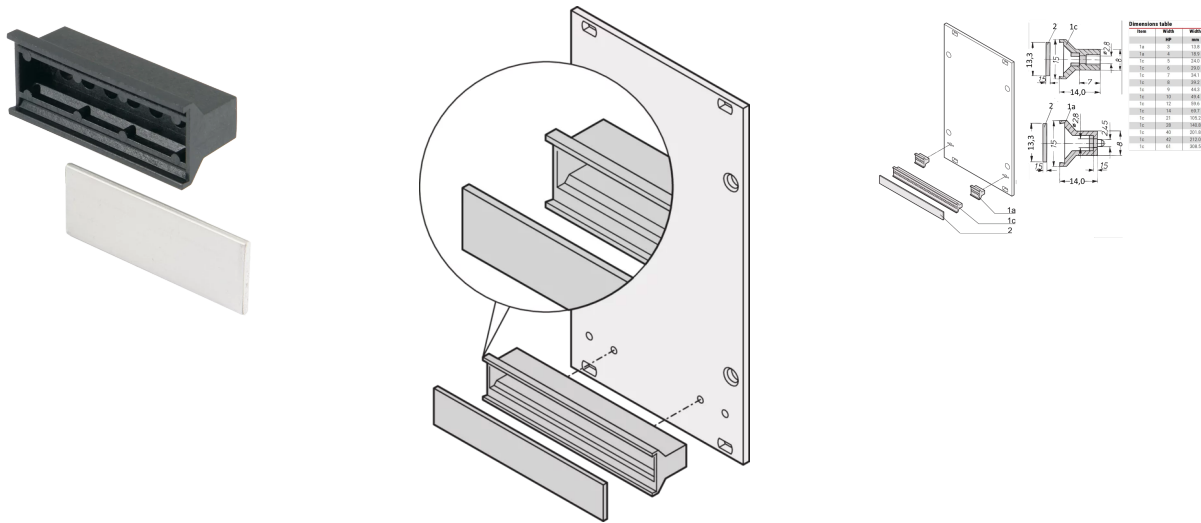

### KEY FEATURES

With separate identification plate, Al 1.5 mm

Handle, PC, UL 94 V-0

### PRODUCT ATTRIBUTES

Product Type: Handle

Type: Static

Works With: Front Panels

Handle Type: Trapezoid, Static

Rack Width: 21 HP

Width: 105.2 mm

Material: Polycarbonate

Color: Black

Flammability Rating: UL® 94V-0

Complies With: EN 45545-2, R22-R24, HL3; IEC 60297-3-101

Package Quantity: 5

## ADDITIONAL PRODUCT DETAILS

---

The static plastic handle, trapezoid form in black color can be mounted to a front panel for extraction of the PCB.

Please take into consideration that deliveries may be carried out in the stated SPQs (SPQ, e.g. 5 pieces, 10 pieces, 50 pieces, etc.). Differing order quantities (e.g. 2 pieces) may be changed to the next possible delivery quantity = Standard Pack Quantity.

Cannot be used together with fixing clip (21101-239).

## CERTIFICATIONS

---



### North America

All locations  
+1.763.422.2661  
Chat with us:  
[schroff.nvent.com](https://schroff.nvent.com)

### Europe

Straubenhardt, Germany  
+49.7082.794.0  
Betschdorf, France  
+33.3.88.90.64.90  
Warsaw, Poland  
+48.22.209.98.35  
Assago, Italy  
+39.02.932.7141  
Chat with us:  
[schroff.nvent.com](https://schroff.nvent.com)

### Asia

Shanghai, China  
+86.21.2412.6943  
Qingdao, China  
+86.532.8771.6101  
Singapore  
+65.6768.5800  
Shin-Yokohama, Japan  
+81.45.476.0271  
Chat with us:  
[schroff.nvent.com](https://schroff.nvent.com)

### Middle East & India

Dubai, United Arab Emirates  
+971.4.378.1700  
Bangalore, India  
+91.80.6715.2001  
Istanbul, Turkey  
+90.216.250.7374  
Chat with us:  
[schroff.nvent.com](https://schroff.nvent.com)



Our powerful portfolio of brands:  
[nVent.com](https://nVent.com) **CADDY ERICO HOFFMAN RAYCHEM SCHROFF TRACER**

© 2023 nVent. All nVent marks and logos are owned or licensed by nVent Services GmbH or its affiliates. All other trademarks are the property of their respective owners.

nVent reserves the right to change specifications without notice.