

20603-002 TIP-UP FOOT FOR CHASSIS, PLASTIC, RAL 7016

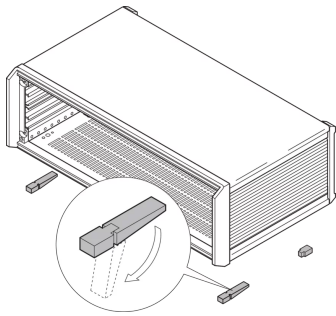
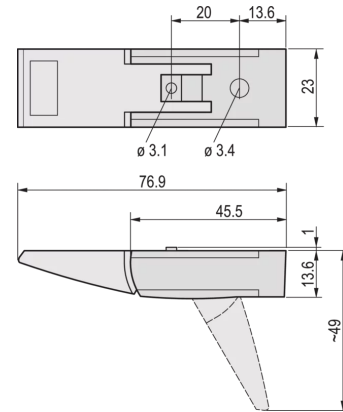
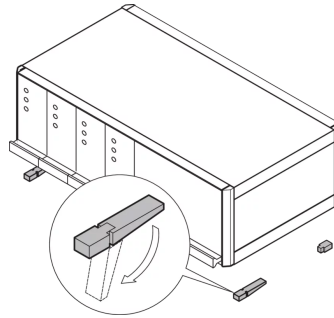

KEY FEATURES

Mounting holes are provided in bottom of case

Load-carrying capacity 25-kg per foot, max case weight: 50-kg

PRODUCT ATTRIBUTES

Product Type: Foot

Type: Foot

Works With: Cases

Package Quantity: 4

ADDITIONAL PRODUCT DETAILS

Flexible and robust Tip-up foot for chassis, with carrying capacity of 25 kg per foot. Suitable for RatiopacPRO/-AIR, PropacPRO, CompacPRO, Comptec and Interscale.

CERTIFICATIONS



North America

All locations
+1.763.422.2661
Chat with us:
schroff.nvent.com

Europe

Straubenhardt, Germany
+49.7082.794.0
Betschdorf, France
+33.3.88.90.64.90
Warsaw, Poland
+48.22.209.98.35
Assago, Italy
+39.02.932.7141
Chat with us:
schroff.nvent.com

Asia

Shanghai, China
+86.21.2412.6943
Qingdao, China
+86.532.8771.6101
Singapore
+65.6768.5800
Shin-Yokohama, Japan
+81.45.476.0271
Chat with us:
schroff.nvent.com

Middle East & India

Dubai, United Arab Emirates
+971.4.378.1700
Bangalore, India
+91.80.6715.2001
Istanbul, Turkey
+90.216.250.7374
Chat with us:
schroff.nvent.com



Our powerful portfolio of brands:
nVent.com **CADDY ERICO HOFFMAN RAYCHEM SCHROFF TRACER**

© 2023 nVent. All nVent marks and logos are owned or licensed by nVent Services GmbH or its affiliates. All other trademarks are the property of their respective owners.

nVent reserves the right to change specifications without notice.