

14575-445 COMPACPRO DESKTOP CASE, UNSHIELDED, 6 U, 63 HP, 331 MM

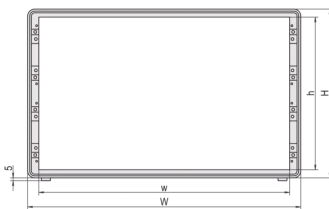
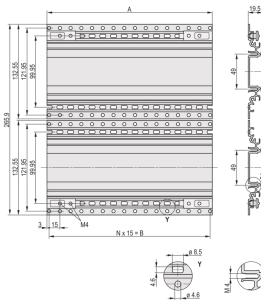
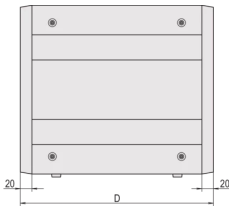
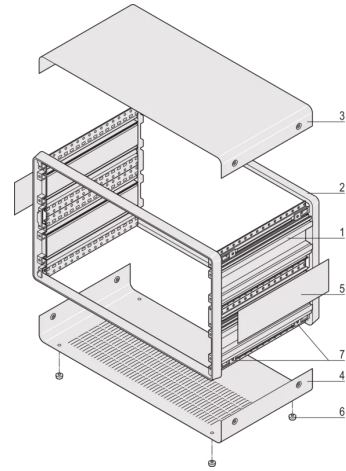
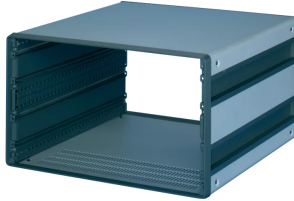

KEY FEATURES

Desktop case for individual assembly

Aluminum construction ensures robust solution

International dimensions in accordance with IEC 6297-3-101

Side panel with integrated handle function

Front and rear identical, depth-symmetrical construction

Ventilation slots in base plate

IP 20 in accordance with IEC 60529

PRODUCT ATTRIBUTES

Product Type: Case

Product Family: CompacPRO

Type: Case for Individual Electronic Components

Rack Height: 6 U

Height: 280.5 mm

Usable Height: 262.9 mm

Rack Width: 63 HP

Width: 364 mm

Usable Width: 326 mm

Depth: 331 mm

EMC Shielding: No

Static Load: 30 kg

Protection Rating: IP20

Front Frame Construction: Single Piece

Cooling Option: No

Complies With: IEC 60297-3-103

Package Quantity: 1

ADDITIONAL PRODUCT DETAILS

The nVent SCHROFF CompacPRO case provides electronics protection for 19" and individual electronic assemblies. The aluminum die cast frame and profile sidepanels guarantee a robust solution. In addition an extensive accessory range is available.

GND / earthing connections in accordance with

CERTIFICATIONS



North America

All locations

+1.763.422.2661

Chat with us:

schroff.nvent.com

Europe

Straubenhardt, Germany

+49.7082.794.0

Betschdorf, France

+33.3.88.90.64.90

Warsaw, Poland

+48.22.209.98.35

Assago, Italy

+39.02.932.7141

Chat with us:

schroff.nvent.com

Asia

Shanghai, China

+86.21.2412.6943

Qingdao, China

+86.532.8771.6101

Singapore

+65.6768.5800

Shin-Yokohama, Japan

+81.45.476.0271

Chat with us:

schroff.nvent.com

Middle East & India

Dubai, United Arab Emirates

+971.4.378.1700

Bangalore, India

+91.80.6715.2001

Istanbul, Turkey

+90.216.250.7374

Chat with us:

schroff.nvent.com



Our powerful portfolio of brands:
nVent.com **CADDY ERICO HOFFMAN RAYCHEM SCHROFF TRACER**

© 2023 nVent. All nVent marks and logos are owned or licensed by nVent Services GmbH or its affiliates. All other trademarks are the property of their respective owners.

nVent reserves the right to change specifications without notice.