

11000-001 PSU WALL-MOUNTING BRACKET FOR 19" PSU

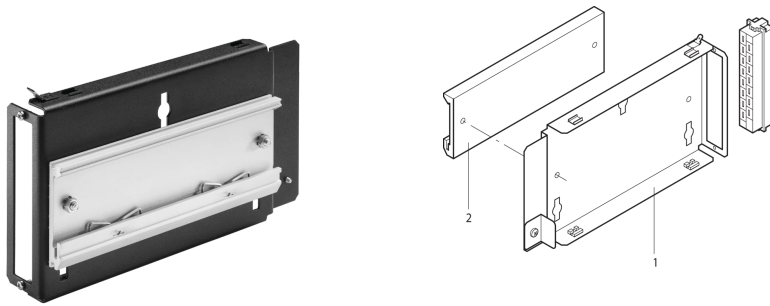

KEY FEATURES

Suitable for 19"-compatible 3 U PSUs

Wall mounting bracket can be assembled in any position with screws

Horizontal rail adaptor is bolted to wall mounting bracket, then the 19" PSU can be clipped to a horizontal rail

PRODUCT ATTRIBUTES

Product Type: Adapter

Type: Wall Mount

Works With: Systems

Material: Steel

ADDITIONAL PRODUCT DETAILS

Wall mounting bracket for nVent SCHROFF 19" Power Supplies.

CERTIFICATIONS



North America

All locations

+1.763.422.2661

Chat with us:

schroff.nvent.com

Europe

Straubenhardt, Germany

+49.7082.794.0

Betschdorf, France

+33.3.88.90.64.90

Warsaw, Poland

+48.22.209.98.35

Assago, Italy

+39.02.932.7141

Chat with us:

schroff.nvent.com

Asia

Shanghai, China

+86.21.2412.6943

Qingdao, China

+86.532.8771.6101

Singapore

+65.6768.5800

Shin-Yokohama, Japan

+81.45.476.0271

Chat with us:

schroff.nvent.com

Middle East & India

Dubai, United Arab Emirates

+971.4.378.1700

Bangalore, India

+91.80.6715.2001

Istanbul, Turkey

+90.216.250.7374

Chat with us:

schroff.nvent.com



Our powerful portfolio of brands:
nVent.com **CADDY ERICO HOFFMAN RAYCHEM SCHROFF TRACER**

© 2023 nVent. All nVent marks and logos are owned or licensed by nVent Services GmbH or its affiliates. All other trademarks are the property of their respective owners.

nVent reserves the right to change specifications without notice.