

## New U-series compact network camera with enhanced functions and affordability

# 4MP Varifocal Lens Outdoor Bullet Network Camera

The new U series is an entry model that achieves high quality and reliability at an affordable price to meet the needs of a wide range of customers. The compact and slim design allows it to be installed in a various locations.

It newly supports ONVIF G / S / T profile and H.265 / H.264, and can be widely used for connecting various VMS and recorders. It also comes pre-installed with secure certificates, enabling device authentication and end-to-end communication encryption to counter the threat of advanced cyberattacks.

### Key features

- Compact and slim design allows installation in various locations
- Compliant with ONVIF G / S / T profile and H.265 / H.264, and can support a wide range of connections to VMS and recorders
- Uses "Easy Kitting Packing" that allows you to set the camera without removing it from the box
- Strengthen cyber security by pre-installing digital certificates issued by a third party organization (GlobalSign)

### Key i-PRO Spec.

- 5MP Sensor
- 2688×1520 pixel image up to 30fps
- 2.5x built-in motorized zoom and motorized focus lens
- iA (intelligent Auto)
- Super Dynamic 102dB
- Color night vision (0.019 to 0.3 lx)
- H.265 Smart Coding
- Corridor mode  
(90 degrees or 270 degrees in image rotation)
- Built-in IR LED
- ONVIF® Profile G / S / T  
\*ONVIF is a trademark of ONVIF, Inc.
- Genetec Stratocast compatible

### Industry examples

- Public safety (City / Highway toll / Parking gate)
- Transportation (Airport / Train / Subway)
- Retail / Bank / Logistics / Education / Hospital / Building



# Specifications

<b>Camera</b>	Image Sensor	Approx. 1/2.7 type CMOS image sensor
	Minimum Illumination	Color : 0.3 lx, BW: 0.12 lx (50IRE, F2.0, Maximum shutter: Off (1/30s), AGC: 11) BW : 0 lx (0 footcandle) (50IRE, F2.0, Maximum shutter: Off (1/30 s), AGC: 11, when the IR LED is lit) Color : 0.019 lx, BW: 0.0075 lx (50IRE, F2.0, Maximum shutter: max. 16/30s, AGC: 11) *1
	White Balance	ATW1/ ATW2/ AWC
	Maximum shutter	<b>[30fps mode]</b> Max. 1/10000 s to Max. 16/30 s <b>[25fps mode]</b> Max. 1/10000 s to Max. 16/25 s
	Intelligent Auto	On / Off
	Super Dynamic	On / Off. The level can be set in the range of 0 to 31.
	Dynamic Range	Max.102 dB (Super Dynamic: On, Level: 31)
	Adaptive Black Stretch	—
	Back light compensation / High light compensation	BLC/ HLC/ Off (only when Super Dynamic/ Intelligent auto: Off)
	Fog compensation	On / Off. The level can be set in the range of 0 to 8. (only when Intelligent auto / auto contrast adjust: Off)
	Maximum gain (AGC)	The level can be set in the range of 0 to 11.
	Color/BW (ICR)	Off/ On (IR Light Off) / On (IR Light On) / Auto1 (IR Light Off) / Auto2 (IR Light On) / Auto3 (SCC)
	IR LED Light	High/ Middle/ Low/ Off Maximum irradiation distance: 20 m (Approx. 65 ft)
	Digital Noise Reduction	The level can be set in the range of 0 to 255.
	Video Motion Detection (VMD)	On / Off, 4 areas available
Scene Change Detection (SCD)	On / Off, 1 areas available	
Privacy Zone	On / Off. Up to 8 zones available	
Image rotation	0° (Off) / 90° / 180° (Upside-down) / 270°	
Camera Title (OSD)	On / Off. Up to 20 characters (alphanumeric characters, marks)	
<b>Lens</b>	Focal length	2.9 mm - 7.3 mm (1/8inches-9/32inches)
	Optical zoom	2.5x (Motorized zoom / Motorized focus)
	Extra optical zoom	2.5x - 3.3x (when resolution is 1920x1080)
	Digital (electronic) zoom	Choose from 3 levels of x1, x2, x4
	Angular Field of View	<b>[16 : 9 mode]</b> * [4:3 mode] is not supported. Horizontal : 44° (TELE) - 103° (WIDE), Vertical : 25° (TELE) - 57° (WIDE)
	Maximum Aperture Ratio	1 : 2.0 (WIDE) - 1 : 3.0 (TELE)
Focus range	1 m (39-3/8 inches) - ∞	
<b>DORI</b>	Detect (25ppm / 8ppf)	Wide: 40.7 m / 133.6 ft, Tele: 126.7 m / 415.8 ft
	Observe (62.5ppm / 19ppf)	Wide: 16.3 m / 53.4 ft, Tele: 50.7 m / 166.3 ft
	Recognize (125ppm / 38ppf)	Wide: 8.1 m / 26.7 ft, Tele: 25.3 m / 83.2 ft
	Identify (250ppm / 76ppf)	Wide: 4.1 m / 13.4 ft, Tele: 12.7 m / 41.6 ft
<b>Adjusting Angle</b>	Ceiling mounting	Horizontal: ±180° (Adjust by horizontal (PAN) angle) Vertical : 0° to 100° (Adjust by vertical (TILT) angle) Yaw : -190° to +100° (Adjust by azimuth (YAW) angle)
	Wall mounting	Horizontal: ±100° (Adjust by vertical (TILT) angle)* Vertical : ±100° (Adjust by vertical (TILT) angle)* Yaw : -190° to +100° (Adjust by azimuth (YAW) angle) *You can change between horizontal and vertical angles by adjusting the horizontal (PAN) angle.
<b>Browser GUI</b>	Camera Control	Brightness
	GUI / Setup Menu Language	English, Italian, French, German, Spanish, Portuguese, Russian, Chinese, Japanese

\*1 Converted value  
\*2 Smart Coding (GOP and AUTO VIQS) is not available when setting 30fps.  
\*3 It may be necessary to upgrade the firmware to use these protocols.  
\*4 Only when installation work is properly performed according to the Installation Guide and appropriate waterproof treatment is performed.

<b>Network</b>	Network IF	10Base-T / 100Base-TX, RJ45 connector				
	Resolution H.265/H.264	<b>[16:9 mode(2688x1520 30fps mode)], [16:9 mode(2688x1520 25fps mode)]</b> 2688x1520, 1920x1080, 640x360, 320x180 <b>[16:9 mode(30fps mode)], [16:9 mode(25fps mode)]</b> 2560x1440, 1920x1080, 640x360, 320x180 * [4:3 mode] is not supported.				
	H.265/ H.264	Transmission Mode	Constant bit rate / VBR / Frame rate / Best effort			
		Transmission Type	Unicast / Multicast			
		Max. frame rate for each stream*2	Stream(1)	Stream(2)	Stream(3)	JPEG(1)
			2688x1520(30fps)	Off	Off	2560x1440(1fps)
			2560x1440(30fps)	640x360(30fps)	Off	2560x1440(1fps)
			1920x1080(30fps)	1920x1080(30fps)	640x360(10fps)	1920x1080(1fps)
	JPEG	Image Quality	10 steps			
		Smart Coding	<b>GOP(Group of pictures) control:</b> On(Frame rate control) / On(Advanced) / On(Mid) / On(Low) / Off *Frame rate control and Advanced are only available with H.265. <b>AUTO VIQS:</b> On/ Off			
		Audio Compression	—			
		Audio transmission mode	—			
		Supported Protocol	IPv6 : TCP/IP, UDP/IP, HTTP, HTTPS, SSL/TLS, SMTP, DNS, NTP, SNMPv1/v2/v3, DHCPv6, RTP, MLD, ICMP, ARP, IEEE 802.1X, DiffServ, MQTT*3, LLDP*3 IPv4 : TCP/IP, UDP/IP, HTTP, HTTPS, SSL/TLS, RTSP, RTP, RTP/RTCP, SMTP, DHCP, DNS, DDNS, NTP, SNMPv1/v2/v3, UPnP, IGMP, ICMP, ARP, IEEE 802.1X, DiffServ, MQTT*3, LLDP*3			
		No. of Simultaneous Users	Up to 14 users (Depends on network conditions)			
		SDXC/SDHC/SD Memory Card	H.265/H.264 recording: Manual REC / Alarm REC (Pre/Post) / Schedule REC Compatible SDXC/SDHC/SD Memory Card : microSDXC memory card: 64 GB, 128 GB, 256 GB, 512 GB microSDHC memory card: 4 GB, 8 GB, 16 GB, 32 GB microSD memory card: 2 GB			
	Mobile Terminal Compatibility	iPad, iPhone, Android™ terminals				
	ONVIF® Profile	G / S / T				
<b>Alarm</b>	Alarm Source	VMD alarm, SCD alarm, Command alarm				
	Alarm Actions	SDXC/SDHC/SD memory recording, E-mail notification, HTTP alarm notification Indication on browser, TCP alarm notification output				
<b>Input/ Output</b>	Monitor Output(for adjustment)	—				
	Audio input	—				
	Audio Output	—				
	External I/O Terminals	—				
<b>General</b>	Safety	UL (UL60950-1), c-UL (CSA C22.2 No.60950-1), CE, IEC60950-1				
	EMC	FCC (Part15 ClassA), ICES003 ClassA, EN55032 ClassB, EN55024				
	Power Source and Power Consumption	PoE (IEEE802.3af compliant) Device: DC48 V 150 mA, Approx. 7.2 W (Class 0 device)				
	Ambient Operating Temperature	-30 °C to +50 °C (-22 °F to +122 °F) {Power On range: -20 °C to +50 °C (-4° F to +122 °F)}				
	Ambient Operating Humidity	10 to 100 % (no condensation)				
	Anti-Condensation System	Temish element				
	Water and Dust Resistance*4	IP66 (IEC 60529), Type 4X (UL50E), NEMA 4X compliant				
	Shock Resistance	IK10 (IEC 62262)				
	Dimensions	112.5 mm (W) x 112.5 mm (H) x 262 mm (D) {4-7/16 inches(W) x 4-7/16 inches(H) x 10-5/16 inches(D)}				
	Mass (approx.)	860 g (1.90 lbs.)				
Finish	Main body: Aluminum die cast/ PC resin, i-PRO white Outer fixing screws: Stainless steel (Corrosion-resistant treatment) Front cover: Polycarbonate resin, Clear					

# Appearance



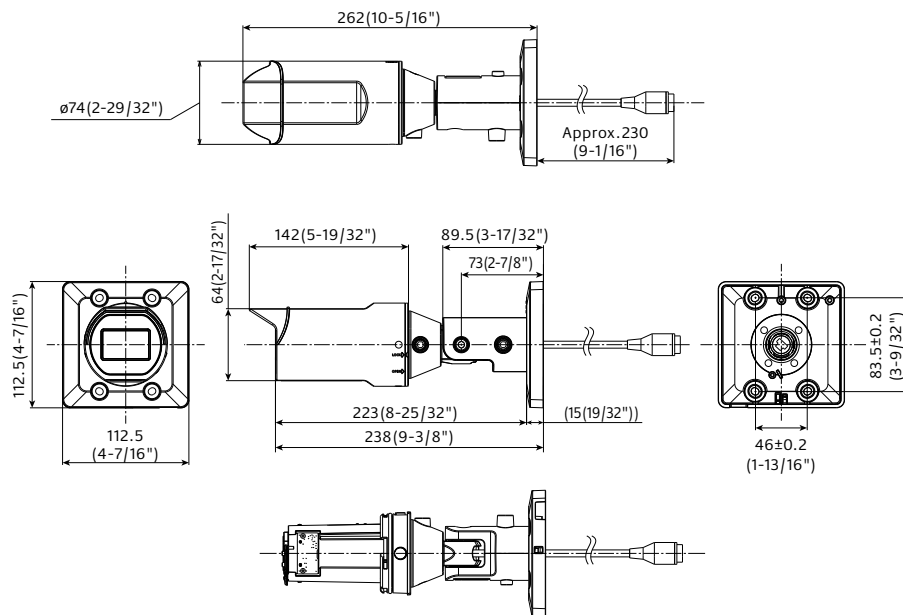



Unit : mm (inches)



Without front cover

# Optional Accessories

## Mount Bracket / Other

	WALL/CEILING	POLE	CORNER	HANGING
combination	1 Adapter Box <b>WV-QJB500-W</b> (White)  *If needed.	1 Pole Mount Bracket <b>PAPM4W</b> (White) 	1 Corner Mount Bracket <b>PACA4W</b> (White) 	1 Ceiling Mount Bracket <b>WV-QCL101-W</b> <sup>*1</sup> (White)  *For indoor installation only.
		Adapter Box <b>WV-QJB500-W</b> (White)  *If needed.	Adapter Box <b>WV-QJB500-W</b> (White)  *If needed.	This bracket requires 1 1/2" NPT pipe.

\*1 : It's possible to be used on the camera side and ceiling side. If used on both side, 2pieces are required.

### Trademarks and registered trademarks

- iPad and iPhone are trademarks of Apple Inc., registered in the U.S. and other countries.
- Android is a trademark of Google LLC.
- ONVIF is a trademark of ONVIF, Inc.
- All other trademarks identified herein are the property of their respective owners.

### Important

- Safety Precautions : Carefully read the Basic Information, Installation Guide and Operating Instructions before using this product.
- i-PRO Co., Ltd. cannot be held responsible for the performance of the network and/or other manufacturers' products used on the network.

• Masses and dimensions are approximate. • Specifications are subject to change without notice.