

# P | Cabling

## Data sheet

**M12 Sensor/actuator cable, A-coded, 5.0 m,  
M12 jack straight - free line end,  
unshielded, 8-pole, PVC**

Page 1/6

P/N  
**142MKA20050**  
EAN **4251394647210**  
2023/05/25  
Version: G

### Illustrations



Dimensional drawing

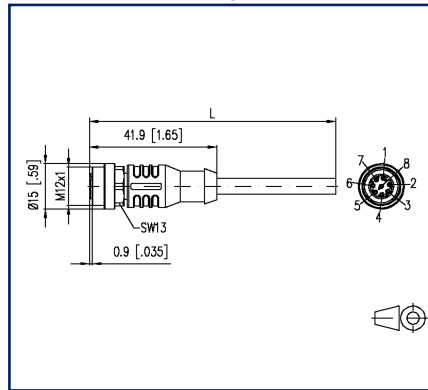

Wiring diagram

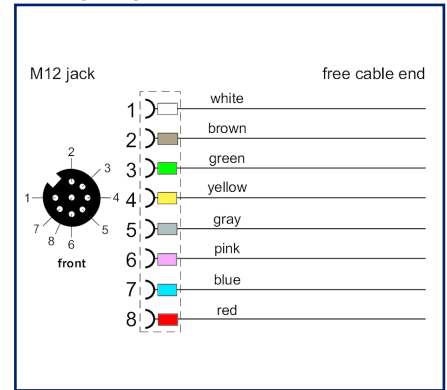

See enlarged drawings at the end of document

### Product specification

PVC-cable for measurement, control and sensor technology. Suitable for applications in dry areas on packaging machines, assembly and conveyor technology. High flexibility with unstressed movement (conditional drag chain application possible). Predestined for applications in food and beverage industry. Special features: seawater resistant, recyclable, LABS free, RoHs compliant, acid and alkali resistant, ozone resistant, UV resistant.

- Standard variants: 1.0 m, 2.0 m, 5.0 m, 10.0 m.
- Other cable lengths on request.



# P | Cabling

Data sheet

Page 2/6

**M12 Sensor/actuator cable, A-coded, 5.0 m,  
M12 jack straight - free line end,  
unshielded, 8-pole, PVC**

P/N  
142MKA20050  
EAN 4251394647210  
2023/05/25  
Version: G

## Technical Data

### General Data

Fields of application	Industrial Ethernet
Design	Sensor/actuator connection cable M12, A-coded
Shielding	unshielded
Transmission technology	Copper
Color coding fiber/ wire(s)	white, brown, green, yellow, gray, pink, blue, red
Color	gray
Dimensions	
Dimension - Interface 1 (L x W x H)	41.9 mm x 15 mm x 15 mm
Dimension - Interface 1 (L x W x H)	1.65 in. x 0.591 in. x 0.591 in.
Cable length (m)	5 m
Cable length (ft)	16.4 ft
Labeling option	identification label carrier

### Connections/interfaces

Connector technology interface 1	M12-jack
Connector technology interface 2	free line end
Coding interface 1	A-coded
Number of positions/contacts interface 1	8
Termination data, stranded wire (min. - max.)	
Conductor cross section, stranded wire	AWG 24/14
Conductor cross section, stranded wire	0.25 mm <sup>2</sup>
Stranded wire structure	14x0.15mm
Cable sheath diameter (min. - max.)	
Cable sheath diameter	5.7 mm
Cable sheath diameter	0.224 in.

### Electrical characteristics

Current carrying capacity	2 A at 40 °C
Rated voltage	30 V
Insulation resistance	min. 100 MOhm

# P | Cabling

Data sheet

Page 3/6

**M12 Sensor/actuator cable, A-coded, 5.0 m,  
M12 jack straight - free line end,  
unshielded, 8-pole, PVC**

P/N  
142MKA20050  
EAN 4251394647210  
2023/05/25  
Version: G

## Technical Data

### Mechanical data

Life - Number of mating cycles	min. 100
Maximum operating bending radius	57 mm
Alternating bending radius	57 mm

### Materials and material properties

Material - Conductor	Cu (copper)
Material - Conductor Insulation	PVC
Material - Cable jacket	PVC
Material - Body interface 1	Plastics
Material - Protective housing interface 1	FPM/FKM
Material - Contact interface 1	CuSn (tin bronze)
Material - Contact finish interface 1	Au (gold)
Material - Contact carriers interface 1	Plastics
Material - Union nut interface 1	CuZnPb (brass)
Material - Union nut finish interface 1	Ni (nickel)
UV-resistance	yes
RoHS	compliant

### Environmental conditions

Temperature (min. - max.)	
Temperature - Operating °C	-25 °C - 80 °C
Temperature - Operating °F	-13 °F - 176 °F
Temperature - Installation °C	0 °C - 80 °C
Temperature - Installation °F	32 °F - 176 °F
Particulate ingress interface 1	IP6X when plugged in
Liquid ingress/immersion interface 1	IPX5, IPX7, IPX8 when plugged in
Pollution degree interface 1	3

# P | Cabling

Data sheet

Page 4/6

**M12 Sensor/actuator cable, A-coded, 5.0 m,  
M12 jack straight - free line end,  
unshielded, 8-pole, PVC**

P/N

142MKA20050

EAN 4251394647210

2023/05/25

Version: G

## Technical Data

### Approvals

UL listed (file no.)	Approval pending
----------------------	------------------

### Standards/Regulations

Connectors for electronic equipment	
-------------------------------------	--

circular connector	DIN EN 61076-2-101
--------------------	--------------------

### Classifications

ETIM 5.0	EC001855
ETIM 6.0	EC001855
ETIM 7.0	EC001855
ETIM 8.0	EC001855
ETIM 9.0	EC001855

### Packing details

Type of packaging	1 pc(s) / plastic bag
-------------------	-----------------------



# P | Cabling

Data sheet

Page 5/6

**M12 Sensor/actuator cable, A-coded, 5.0 m,  
M12 jack straight - free line end,  
unshielded, 8-pole, PVC**

P/N  
142MKA20050  
EAN 4251394647210  
2023/05/25  
Version: G

## Illustrations

Dimensional drawing

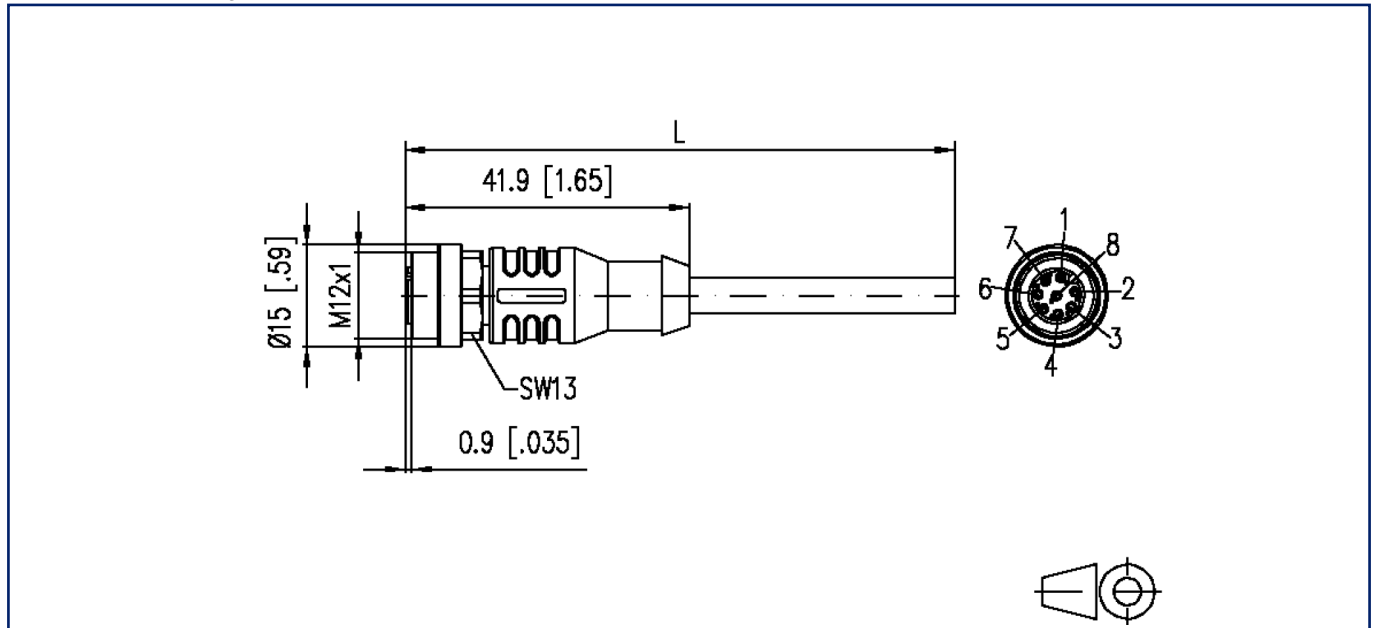

Wiring diagram

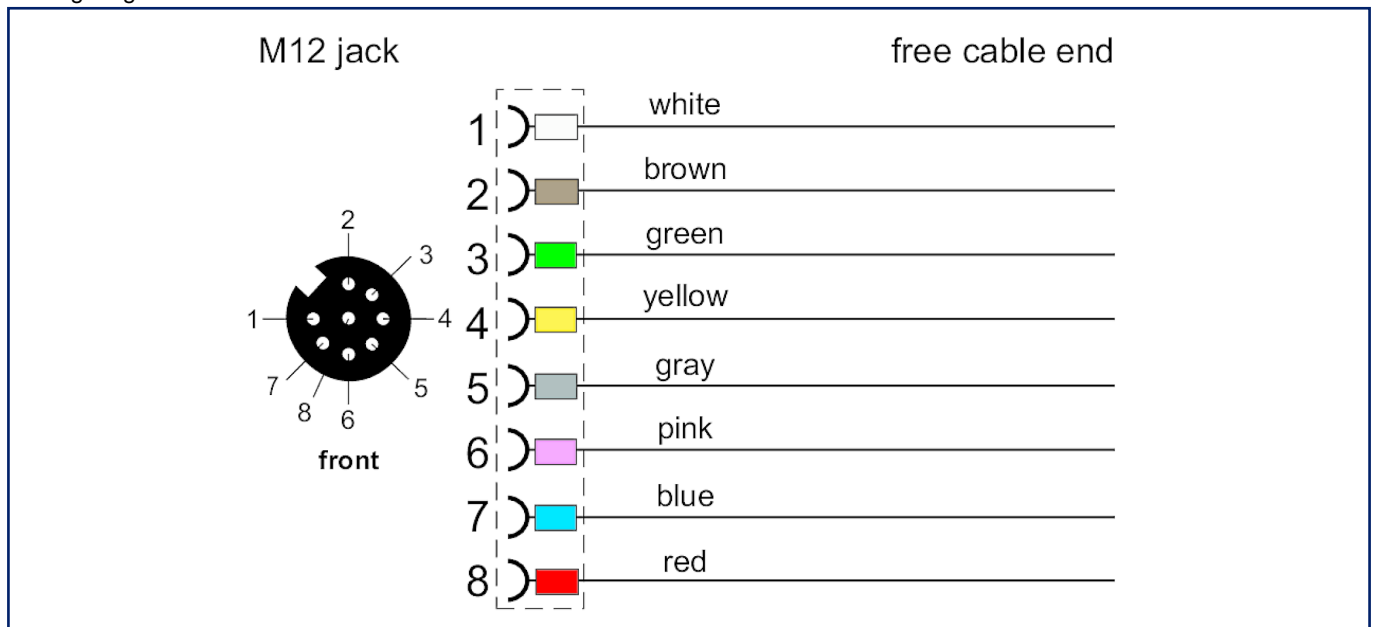

# P | Cabling

Data sheet

**M12 Sensor/actuator cable, A-coded, 5.0 m,  
M12 jack straight - free line end,  
unshielded, 8-pole, PVC**

Page 6/6

P/N

142MKA20050

EAN 4251394647210

2023/05/25

Version: G

## Illustrations

Principle diagram

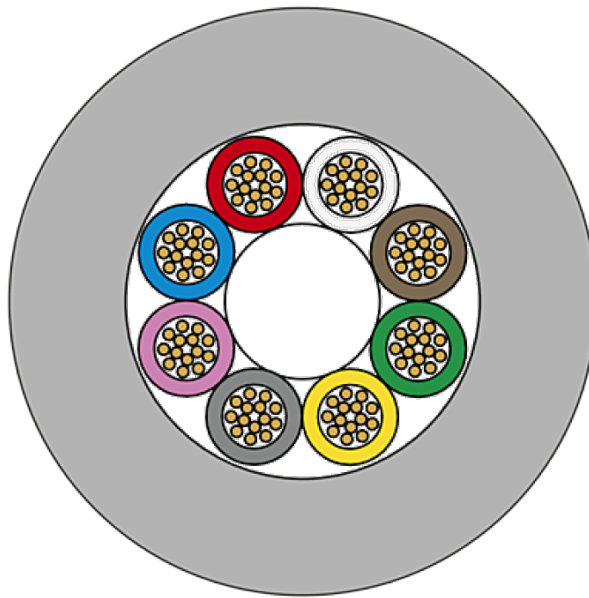

© 2023 METZ CONNECT - Technische Änderungen vorbehalten! Subject to modifications! Sous réserve de modifications techniques!

