

Data sheet

**M12 Industrial Ethernet cable, D-coded, 5.0 m,
M12 plug straight - RJ45 plug straight, drag chain, PUR**

Page 1/7

P/N
142M1D15050
EAN 4250184198406
2023/05/08
Version: AS

Illustrations



Dimensional drawing

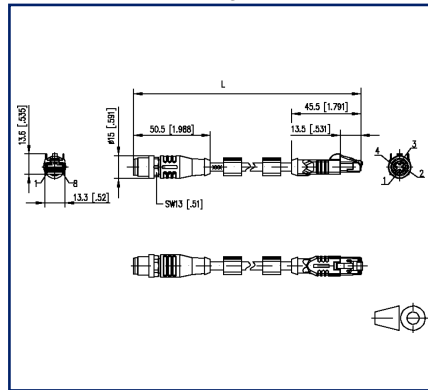

Wiring diagram

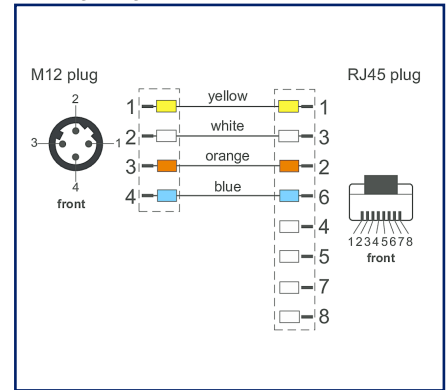

See enlarged drawings at the end of document

Product specification

Shielded PUR cable for safe and industrial data transmission in automation and fieldbus technology. The cable is CMX-verified and complies with Cat5e (electrical properties based on EN50288-2-1). Materials and constructional design allow increased mechanical stress (abrasion, bending, vibrations etc.) of the cable. Use in drag chains with up to 3 million bending cycles is possible without risk. Special properties: flame retardant, seawater resistant, recyclable, LABS-free, RoHS compliant, acid and alkali resistant, ozone resistant, UV resistant, hydrolysis resistant, drag chain compatible, halogen free, oil resistant, high flexibility, microbe resistant, UN ECER118, PROFINET Type C.

- Standard variants: 1.0 m, 2.0 m, 5.0 m, 10.0 m.
- Other cable lengths on request.

P | Cabling

Data sheet

Page 2/7

M12 Industrial Ethernet cable, D-coded, 5.0 m, M12 plug straight - RJ45 plug straight, drag chain, PUR

P/N
142M1D15050
EAN 4250184198406
2023/05/08
Version: AS

Technical Data

General Data

Fields of application	Industrial Ethernet
Design	Ethernet-Connection line
Shielding	shielded
Transmission technology	Copper
Cable Type	SF/FTP
Number of twisting elements	2
Twisting element	Pair
Wiring	Profinet
Color coding fiber/ wire(s)	yellow, white, orange, blue
Color	green
Dimensions	
Dimension - Interface 1 (L x W x H)	50.5 mm x 15 mm x 15 mm
Dimension - Interface 1 (L x W x H)	1.988 in. x 0.591 in. x 0.591 in.
Dimension - Interface 2 (L x W x H)	45.5 mm x 13.3 mm x 13.6 mm
Dimension - Interface 2 (L x W x H)	1.791 in. x 0.524 in. x 0.535 in.
Cable length (m)	5 m
Cable length (ft)	16.4 ft
Labeling option	identification label carrier

Transmission characteristics

Category (ISO)	5e
Transmission rate up to 100 MBit (Fast Ethernet)	IEEE 802.3u

Connections/interfaces

Connector technology interface 1	M12-plug
Connector technology interface 2	RJ45 plug
Coding interface 1	D-coded
Number of positions/contacts interface 1	4
Number of positions/contacts interface 2	8P/4C

P | Cabling

Data sheet

Page 3/7

M12 Industrial Ethernet cable, D-coded, 5.0 m, M12 plug straight - RJ45 plug straight, drag chain, PUR

P/N

142M1D15050

EAN 4250184198406

2023/05/08

Version: AS

Technical Data

Connections/interfaces

Termination data, stranded wire (min. - max.)

Conductor cross section, stranded wire	AWG 22/7
Conductor diameter, stranded wire (bare copper)	0.75 mm
Conductor diameter, stranded wire (bare copper)	0.03 in.
Cable sheath diameter (min. - max.)	
Cable sheath diameter	6.5 mm
Cable sheath diameter	0.236 in.

Electrical characteristics

Current carrying capacity	1 A at 40 °C
Rated voltage	60 V DC
UL rating (cable)	600 V
Insulation resistance	min. 100 MOhm

Mechanical data

Life - Number of mating cycles	min. 100
Bending radius without load	min. 49 mm
Maximum operating bending radius	26 mm
Maximum operating bending radius	1.024 in.
Maximum installation load	52 mm
Maximum installation load	2.047 in.
Number of alternating bending cycles (mechanical resistance) at:	3 million bending cycles
Alternating bending radius	100 mm
velocity	4 m/s
acceleration	4 m/s ²
Shielding braid coverage	85 %
Installation method	PROFINET type C

P | Cabling

Data sheet

Page 4/7

M12 Industrial Ethernet cable, D-coded, 5.0 m, M12 plug straight - RJ45 plug straight, drag chain, PUR

P/N

142M1D15050

EAN 4250184198406

2023/05/08

Version: AS

Technical Data

Materials and material properties

Material - Conductor	Cu (copper)
Material - Conductor Insulation	Polyethylene
Material - Cable jacket	PUR
Material - Inner cable jacket	FRNC, with an aluminized film
Material - Body interface 1	Plastics
Material - Body interface 2	Plastics
Material - Contact interface 1	CuZnPb (brass)
Material - Contact interface 2	CuZnPb (brass)
Material - Contact finish interface 1	Au (gold)
Material - Contact finish interface 2	Au (gold)
Material - Contact carriers interface 1	Plastics
Material - Contact carriers interface 2	Plastics
Material - Union nut interface 1	CuZnPb (brass)
Material - Union nut finish interface 1	Ni (nickel)
Material - Pair shield	plastic film
Material - Pair shield finish	Al (Aluminium)
Material - Main shield	Cu (copper) braid
Material - Main shield finish	Sn (tin)
Flame retardancy	according to IEC 60332-1-2
Halogen free	yes
Oil resistance	yes
UV-resistance	yes
drag chain suitable	yes
RoHS	compliant

Environmental conditions

Temperature (min. - max.)	
Temperature - Operating °C	-30 °C - 70 °C
Temperature - Operating °F	-22 °F - 158 °F
Particulate ingress interface 1	IP6X when plugged in
Liquid ingress/immersion interface 1	IPX5, IPX7, IPX8 when plugged in
Particulate ingress interface 2	IP2X when plugged in
Liquid ingress/immersion interface 2	IPX0 when plugged in



P | Cabling

Data sheet

Page 5/7

M12 Industrial Ethernet cable, D-coded, 5.0 m, M12 plug straight - RJ45 plug straight, drag chain, PUR

P/N

142M1D15050

EAN 4250184198406

2023/05/08

Version: AS

Technical Data

Environmental conditions

Pollution degree interface 1	3
Pollution degree interface 2	1

Approvals

UL listed (file no.)	Approval pending
----------------------	------------------

Standards/Regulations

Generic cabling systems	
General requirements	ISO/IEC 11801-1 DIN EN 50173-1
Profinet	yes
Connectors for electronic equipment	
Free and fixed connectors	DIN EN 60603-7
circular connector	DIN EN 61076-2-101
Multi-element metallic cables used in analogue and digital communication and control	DIN EN 50288-2-1
Common test methods for cables under fire conditions	
UN ECE-R 118.01	R118
Test for vertical flame propagation for a single insulated wire or cable	IEC 60332-1-2
Measurement of smoke density of cables burning	DIN EN 61034

Classifications

ETIM 5.0	EC002599
ETIM 6.0	EC002599
ETIM 7.0	EC002599
ETIM 8.0	EC002599
ETIM 9.0	EC002599

Packing details

Type of packaging	1 pc(s) / plastic bag
-------------------	-----------------------

P | Cabling

Data sheet

Page 6/7

**M12 Industrial Ethernet cable, D-coded, 5.0 m,
M12 plug straight - RJ45 plug straight, drag chain, PUR**

P/N

142M1D15050

EAN 4250184198406

2023/05/08

Version: AS

Illustrations

Dimensional drawing

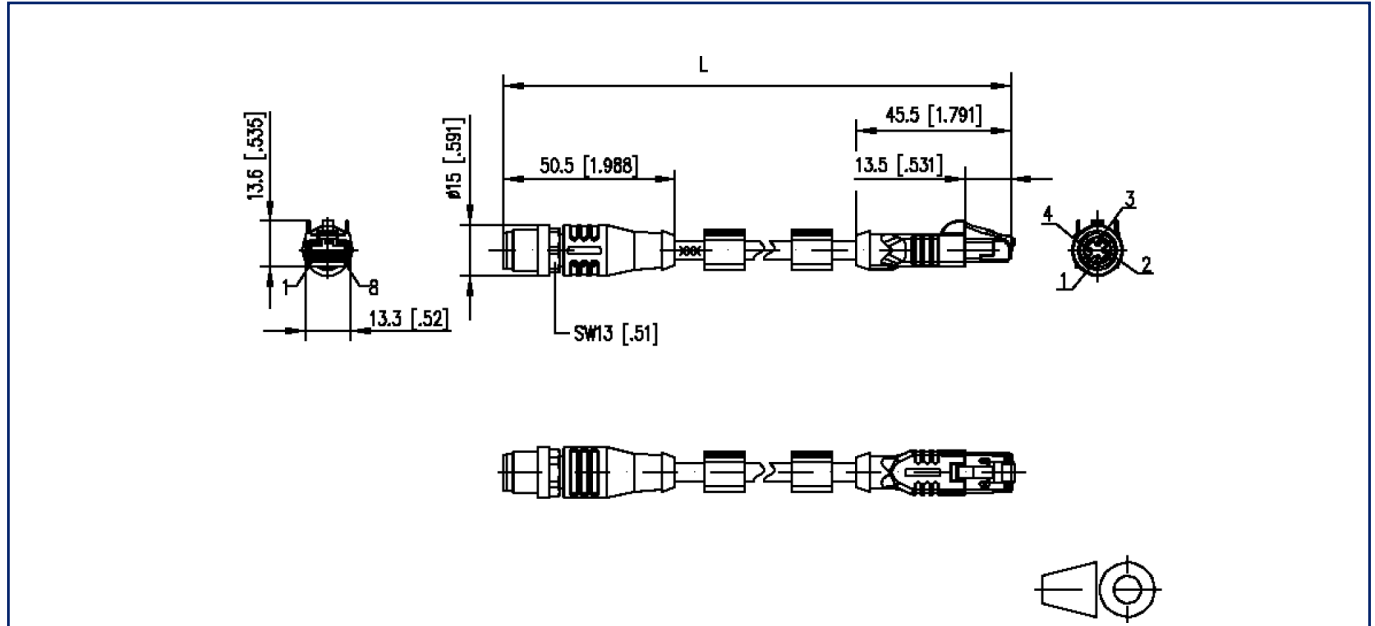

Wiring diagram

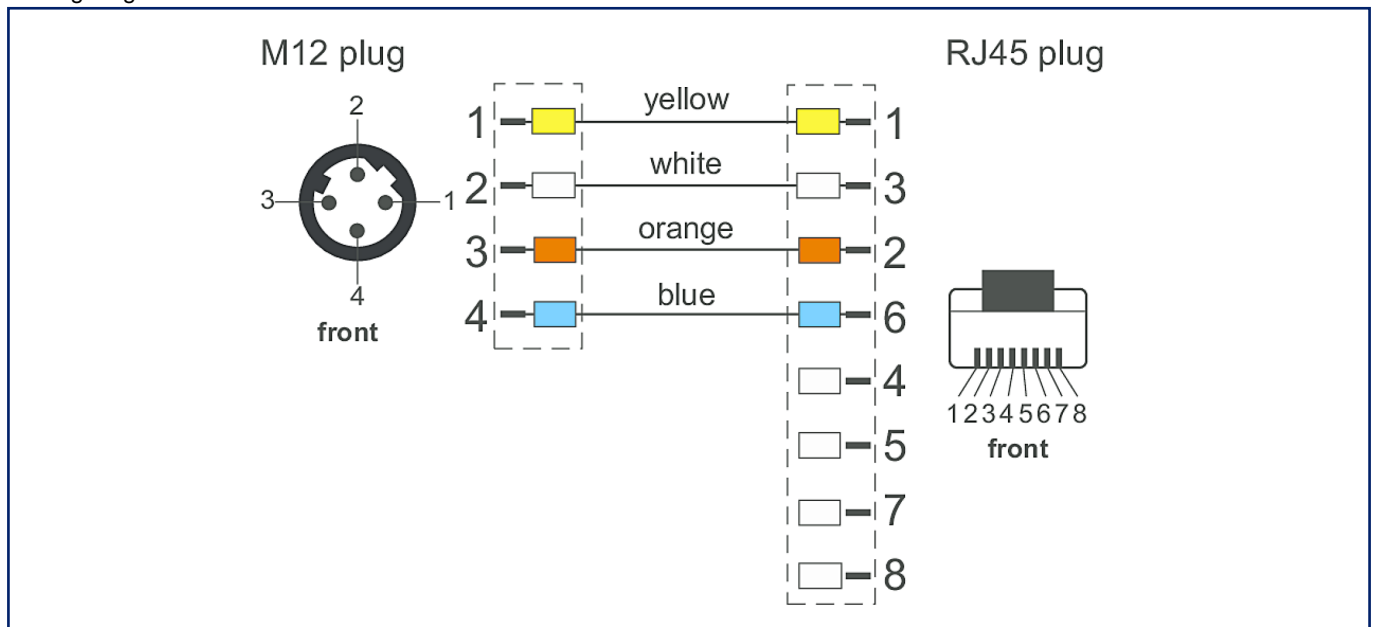

P | Cabling

Data sheet

Page 7/7

**M12 Industrial Ethernet cable, D-coded, 5.0 m,
M12 plug straight - RJ45 plug straight, drag chain, PUR**

P/N

142M1D15050

EAN 4250184198406

2023/05/08

Version: AS

Illustrations

Principle diagram

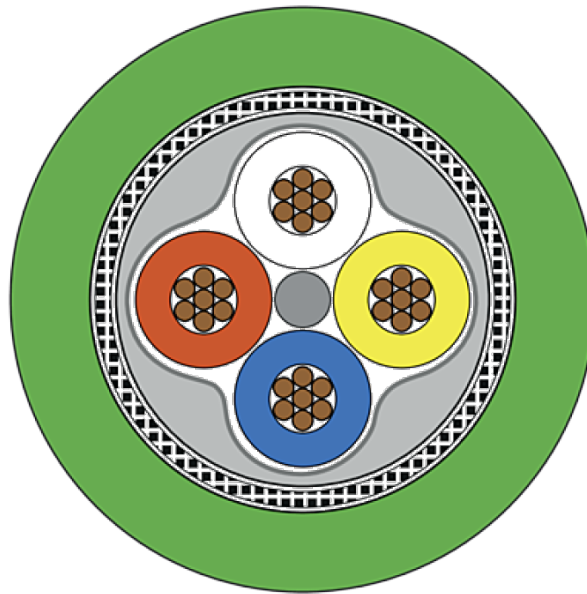

© 2023 METZ CONNECT - Technische Änderungen vorbehalten! Subject to modifications! Sous réserve de modifications techniques!

