

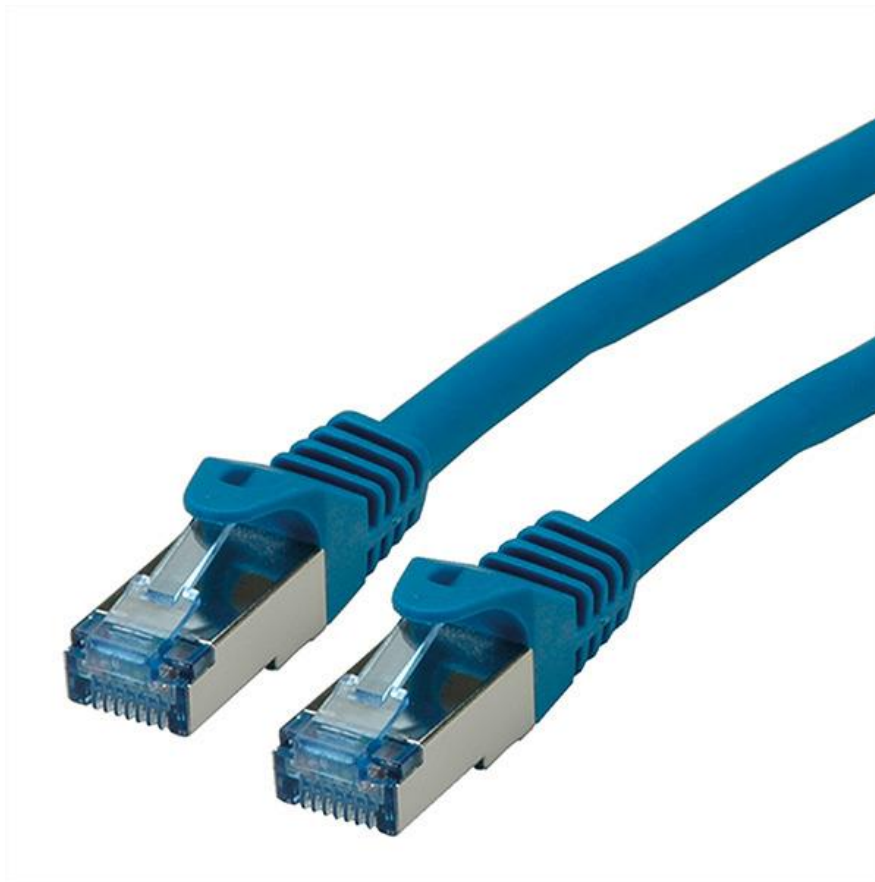

Datenblatt - Fiche technique - Data sheet

21.15.2845



ROLINE Patchkabel Kat.6A S/FTP (PiMF), Comp. Level, LSOH, blau, 5,0 m

Cordon ROLINE S/FTP(PiMF) Cat.6A / 10 Gigabit, LSOH, Component Level,
bleu, 5,0 m

ROLINE S/FTP Patch Cord Cat.6A, Component Level, LSOH, blue, 5.0 m

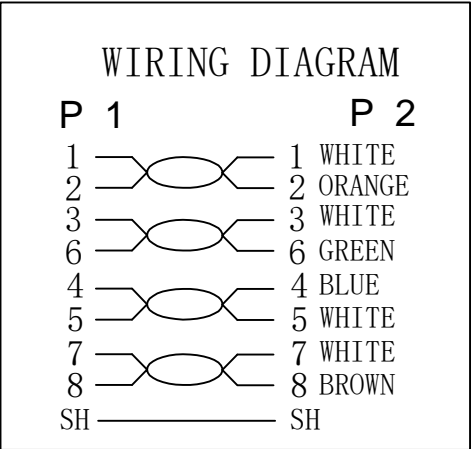
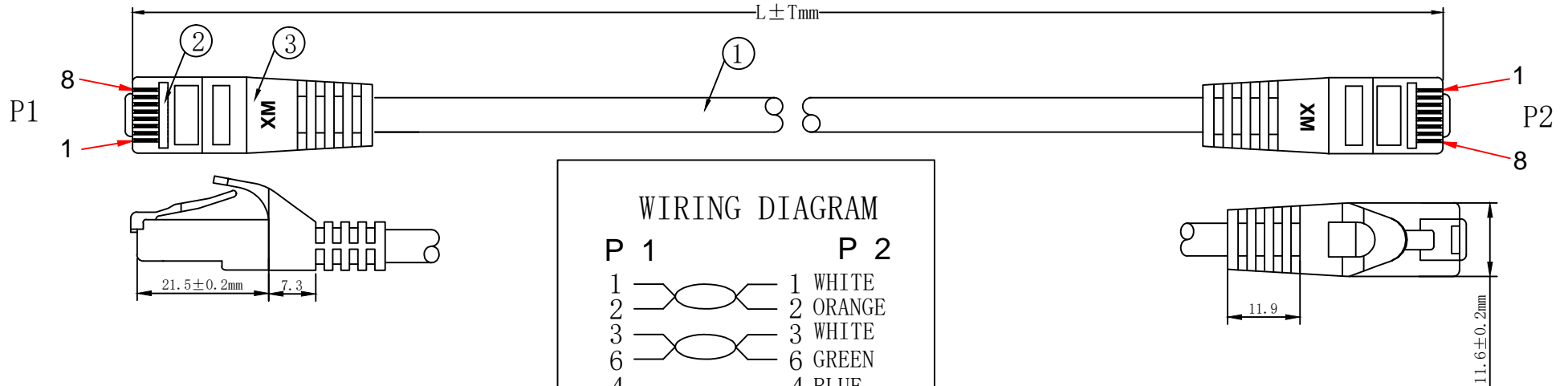

1. ELECTRICAL TEST:

- (1).100% OPEN SHORT & MISS WIRE TEST;
- (2).INSULATION RESISTANCE:DC 250V 20M OHM MIN;
- (3).CONTACTOR RESISTANCE:30 OHM MAX

2.PRINTING:GHMT® roline CAT.6A S/FTP COMPONENT PATCH CORD LSZH 500MHZ ISO/IEC 11801 & EN 50173-1 & ANSI/TIA-568-C.2

3.100% Component Patch cord Test PASS

4.Minimum bending radius:60mm

MATERIAL LIST

⑥	LABEL	NO DRY GLUE LABEL	1PCS	
⑤	MINI TIE	PE MINI TIE(POSSESS METAL)	2PCS	
④	POLYETHYLENE BAG	POLYETHYLENE BAG	1PCS	
③	OVER MOLD	88A PVC blue	2PCS	
②	CONNECTOR	RJ45 8P8C'S SHIELDED PIN GOLD PLATED 3u", SHELL PLATED NICKEL Transparent Blue	2PCS	
①	CABLE	S/FTP CAT.6A 26AWG (BC*1P+AL-FOIL)*4P+BRAID CABLE JACKET LSOH OD=6.2±0.2MM	1PCS	
NO.	PARTS NAME	SPECIFICATION STANDARD	QT' Y	REMARK

COLOUR:blue (PANTONE:647C)					
ITEM NO.	LENGTH(L)		TOLERANCE(T)		
21.15.2974	300mm		±10mm		
21.15.2840	500mm		±15mm		
21.15.2841	1000mm		±30mm		
21.15.2844	1500mm		±45mm		
21.15.2842	2000mm		±60mm		
21.15.2843	3000mm		±90mm		
21.15.2845	5000mm		±150mm		
21.15.2846	7500mm		±210mm		
21.15.2847	10000mm		±300mm		
21.15.2848	15000mm		±450mm		
21.15.2849	20000mm		±600mm		
ITEM NO.	21.15.2974	21.15.2840	21.15.2841	21.15.2842	21.15.2843
21.15.2844	21.15.2845	21.15.2846	21.15.2847	21.15.2848	21.15.2849
DESC.	ROLINE S/FTP PatchCord CAT.6A, LSOH, Comp.Level1, blue				

SECOMP

BY	CHK	NEW	2016-09-13	A
		REVISION RECORD MODIFICATIONS	DATE	REV.